

# ELTS

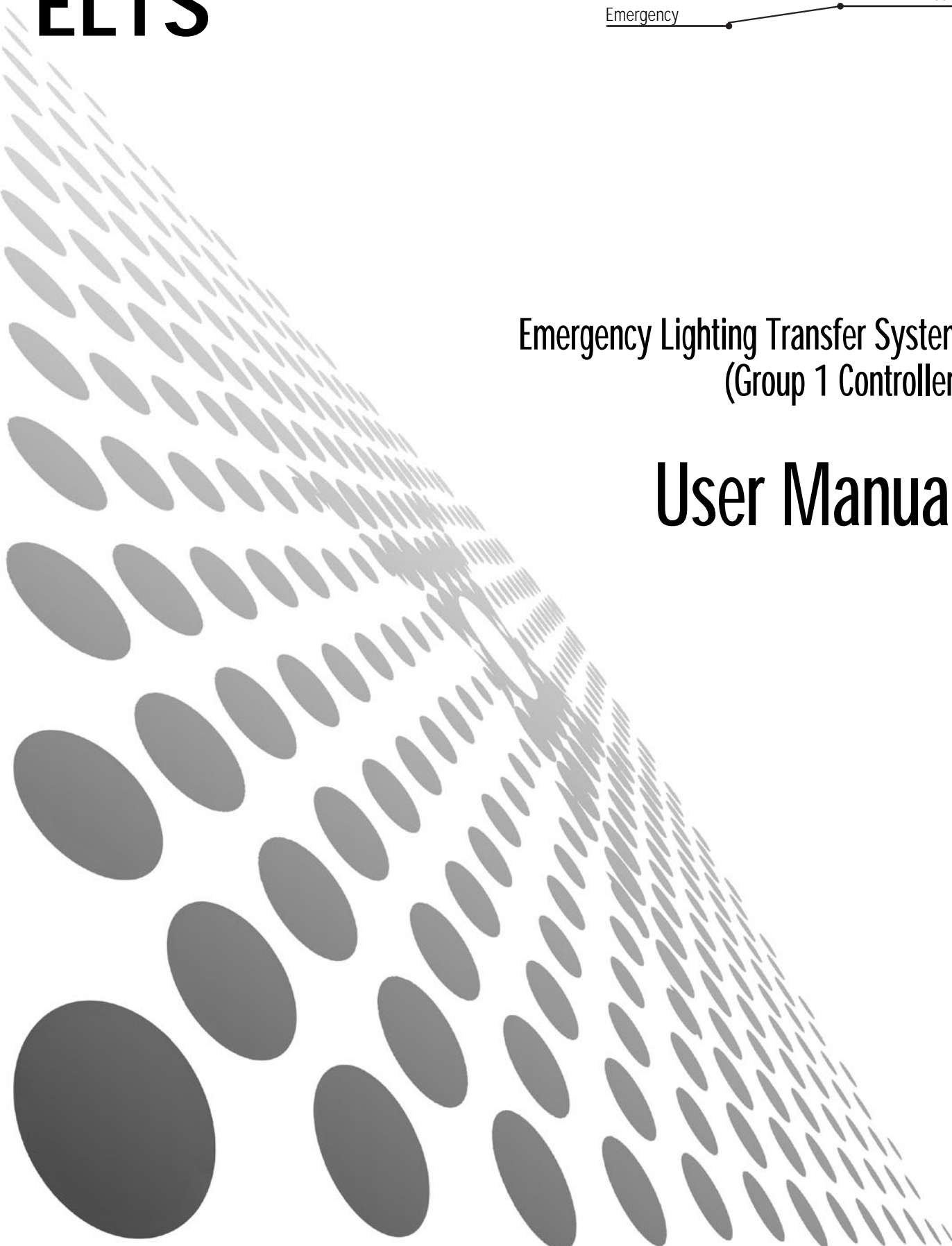

Emergency Lighting Transfer System  
(Group 1 Controller)

# User Manual





# Contents

<b>Introduction</b> .....	5
How to use this manual .....	5
Codes and standards.....	5
System Diagram.....	6

## Installation and setup chapters

<b>Installation</b> .....	7
Unpack and Inspect.....	7
ELTS Models.....	8
Mounting the ELTS cabinet.....	9
Installing Remote stations (optional) .....	11
<b>Connecting power and control wiring to the ELTS cabinet</b> .....	12
Connecting Emergency power (standard systems) .....	12
Connecting Emergency power (Discrete systems).....	13
Connecting lighting circuit wires to transfer switches .....	14
Control and sensing wire connections .....	16
<b>Testing</b> .....	19
Before you power up for the first time .....	19
Turn on system .....	19
Functional checkout .....	20
<b>ELTS Timing, Voltage, and Line settings</b> .....	22
Changing ELTS settings .....	23
Changing the Voltage Adjust setting.....	25

## Use and service chapters

<b>Operation</b> .....	27
Automatic operation.....	27
Switching power sources manually .....	28
<b>Service</b> .....	30
Preventive maintenance.....	30
<b>Troubleshooting</b> .....	31
Emergency or Normal Power Stable LED does not turn on properly.....	31
The ELTS will not switch between Normal and Emergency.....	31
Remote stations cannot switch the ELTS.....	32

## Appendices

<b>Appendix A: ELTS specifications</b> .....	33
<b>Appendix B: Wire connection schematics and diagrams</b> .....	34
<b>Appendix C: Transfer switch control system schematics</b> .....	36
<b>Appendix D: Transfer switch load switching schematic</b> .....	37
<b>Appendix E: Test and Maintenance Log</b> .....	38
<b>Appendix F: Glossary</b> .....	39



# Emergency Lighting Transfer System

## Introduction

Welcome to ETC's Emergency Lighting Transfer System (ELTS) User Manual. This manual shows you how to install and use your ELTS system. See *ELTS Models* on page 8 for a breakdown of ELTS models and configurations.

### How to use this manual

This manual is divided into three sections:

- ▼ *Installation* on page 7 tells you how to install and test your system
- ▼ *Operation* on page 27 tells you how to use and service your system
- ▼ *Appendix B: Wire connection schematics and diagrams* on page 34 contains additional information you may need

### Warnings and Caution symbols

These symbols alert you to danger or important information:



**Warning!** Warns you when electricity may cause injury



**Warning!** Warns you when there is a possibility of other types of injury



**Caution** Alerts you to important information relating to equipment performance or reliability

### Contacting ETC

For questions about ELTS system delivery or general information, contact ETC Customer Service at 800/688-4116.

### Codes and standards

ELTS systems meet the following regulatory standards for emergency lighting transfer devices:

- ▼ ANSI/UL 1008 – Listed, Automatic Transfer Switches
- ▼ ANSI/NFPA 110 – Emergency and Standby Power Systems
- ▼ ANSI/NFPA 70 – National Electric Code
  - Article 701 – Legally Required Standby Systems
  - Article 700 – Emergency Systems
  - Article 540 – 11(c) – Motion Picture Houses
  - Article 520 – 7 – Theatres and Similar Locations
  - Article 518 – 3(c) – Places of Assembly
- ▼ City of New York, Advisory board, Electrical Department
- ▼ OSHA
- ▼ Department of Defense

# System Diagram

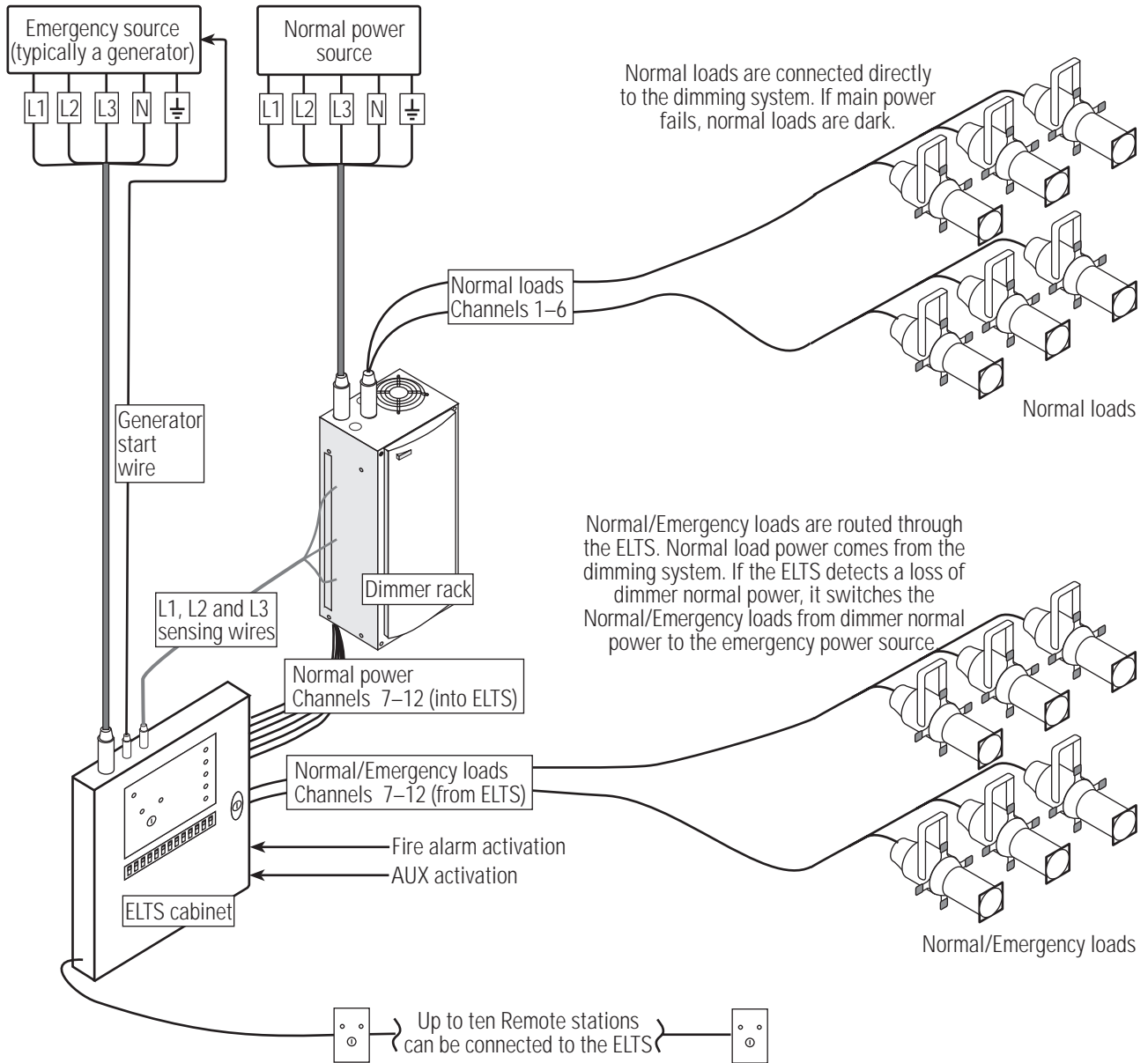

Figure 1: Diagram of a typical ELTS system

# Installation

## Unpack and Inspect

Before you begin installation, check your shipment so you know it arrived complete and undamaged.

1. Check the shipping container for obvious physical damage:
  - ▼ Torn or opened containers
  - ▼ Water stains or wetness
  - ▼ Crushed or punctured boxes
  - ▼ Other shipping-related damage
2. If you find damage, document it to help with a claim against your shipper.
3. Unpack your order and check the contents against the Bill of Materials to be sure your order is complete.

**Note:** ELTS systems are available as either single or three phase products. Make sure your ELTS type matches your phase configuration.

4. Open the ELTS cabinet door and check for loose connections or broken components caused by shipping vibration.
5. If you discover a problem with your order, call ETC Customer Service at 800/688-4116.

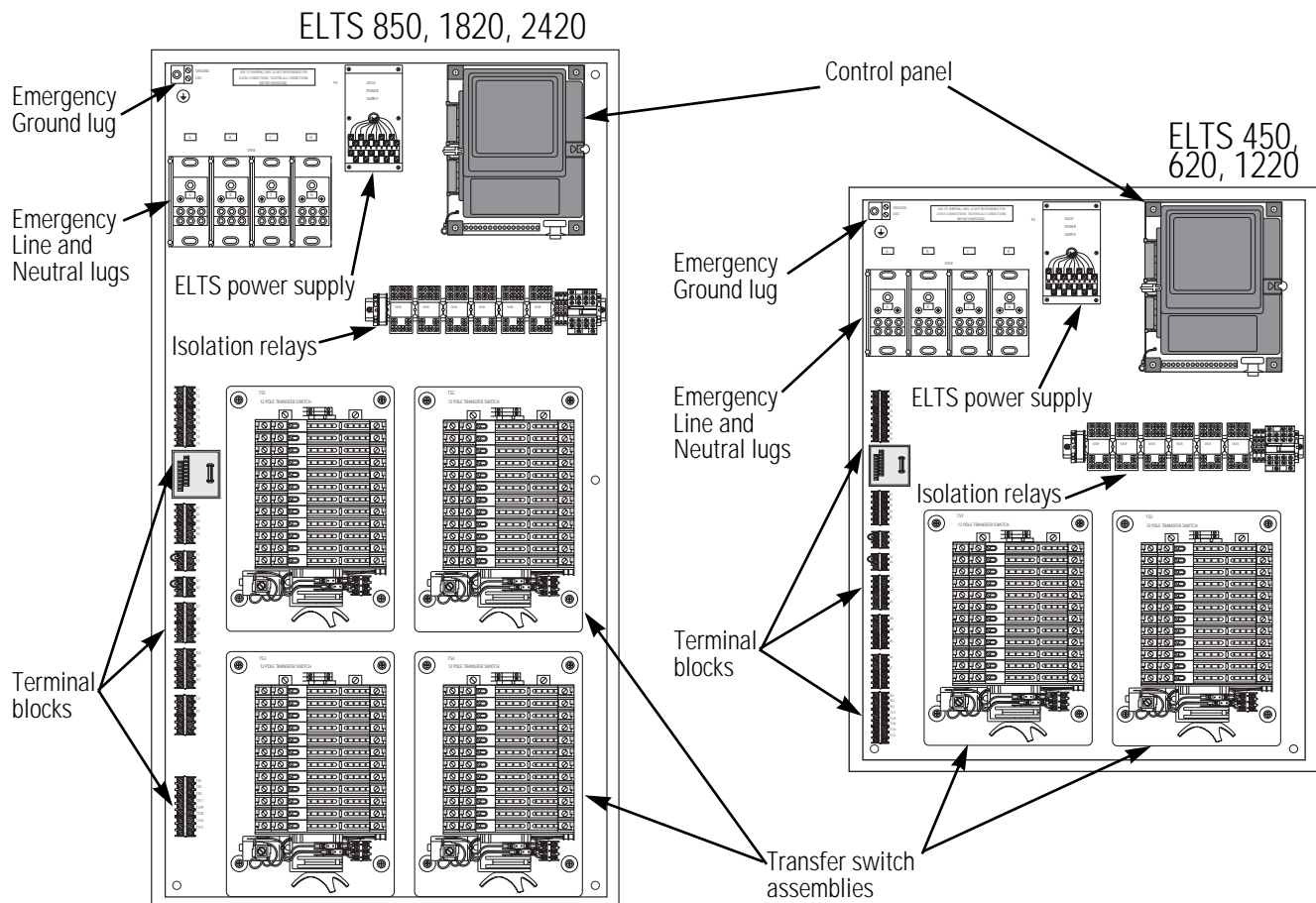
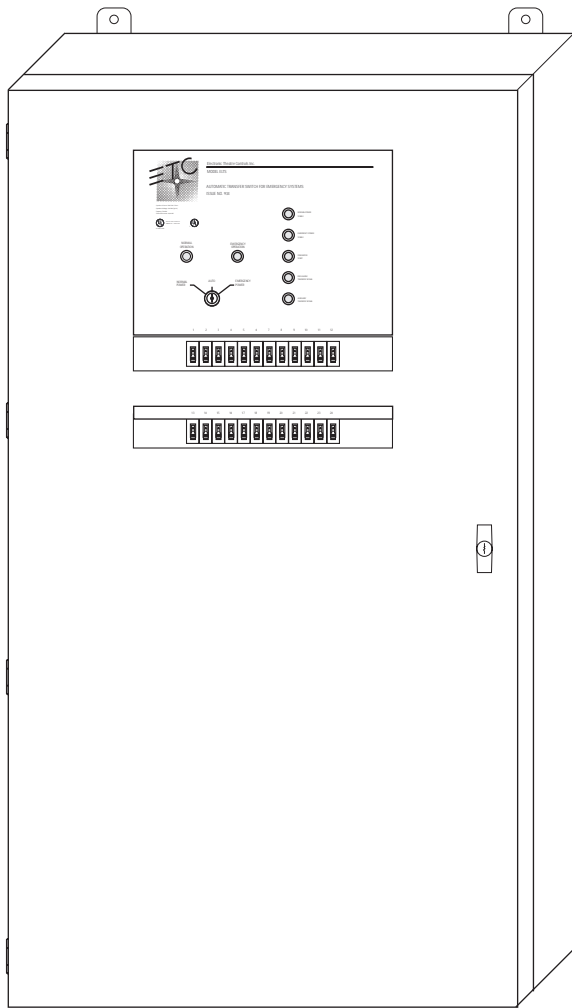

Figure 2: Identifying ELTS components

## ELTS Models



Large ELTS cabinet (30" wide x 54" tall x 9" deep)

<b>ELTS 850</b>	8 circuits of 50 amps
<b>ELTS 1820</b>	18 circuits of 20 amps
<b>ELTS 2420</b>	24 circuits of 20 amps

Small ELTS cabinet (30" wide x 36" tall x 9" deep)

<b>ELTS 450</b>	4 circuits of 50 amps
<b>ELTS 620</b>	6 circuits of 20 amps
<b>ELTS 1220</b>	12 circuits of 20 amps

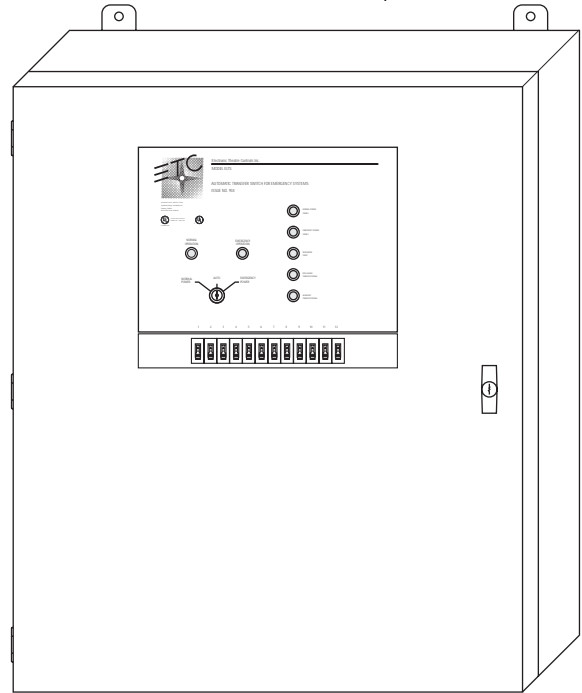

Figure 3: Large and small ELTS cabinets

### Single or three phase ELTS

ELTS systems are available as either single or three phase products and will not operate on phase configurations they are not designed for.

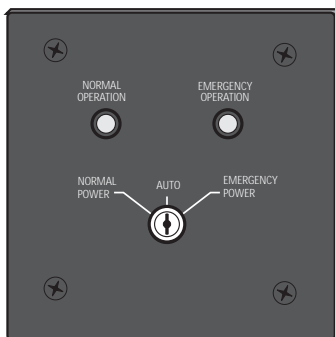

Figure 4: Remote station

### Remote station (part # 1093A2023)

- ▼ Provides front panel keyswitch control at remote locations
- ▼ Link up to ten stations with parallel wiring
- ▼ Normal and Emergency LEDs indicate ELTS status



## Mounting the ELTS cabinet

Mount the ELTS on a load-bearing wall, in a location where it will not be subject to tampering or vandalism. If possible, install the ELTS where it is most secure from damage by a fire, flood or other incident likely to require its use. Do not install the ELTS inside any other electrical enclosure.

### Physical requirements for mounting

You must mount either size ELTS cabinet with sufficient front clearance (30 inches) to allow the door to open completely.

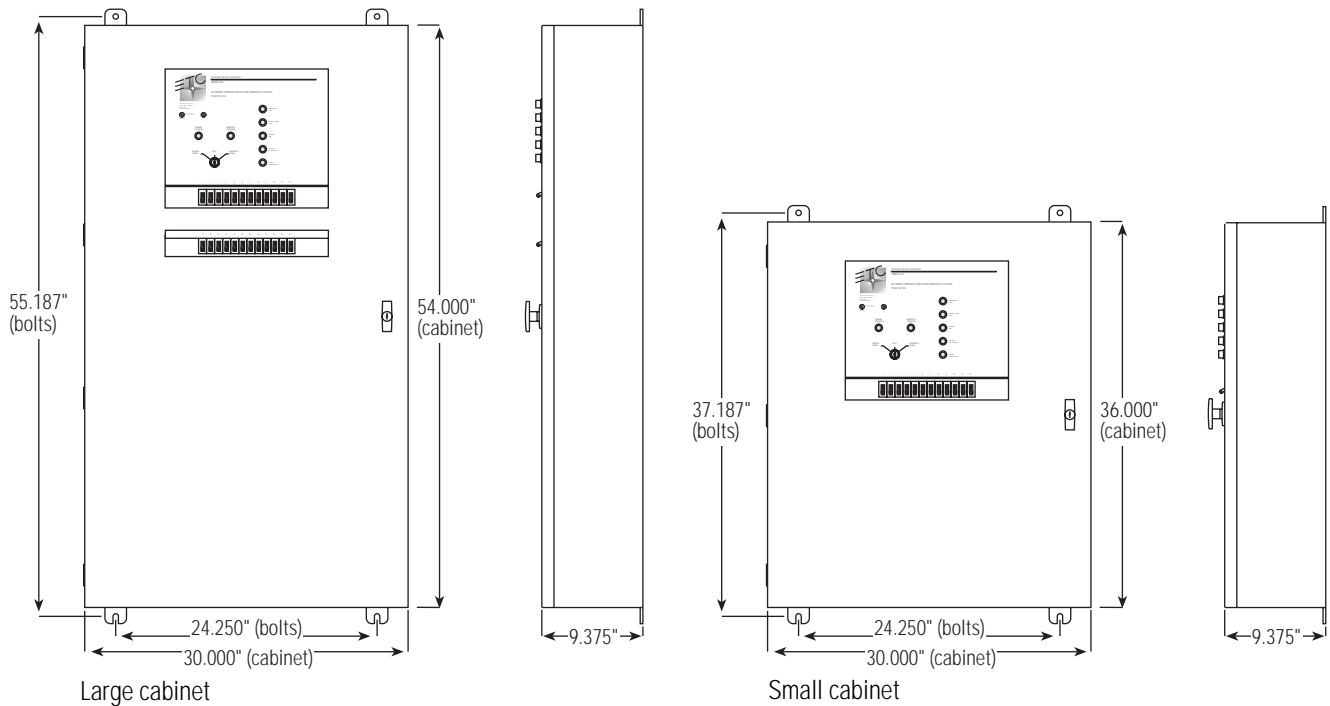

Figure 5: ELTS cabinet mounting dimensions

**Note:** When planning your installation, make sure to leave space around the cabinet for entry and exit wire conduit. Emergency line and neutral conduit may require extra space due to increased bend radius requirements for larger cables.

## Planning wire entry into the ELTS cabinet

The Emergency power connections must enter the cabinet from the top or side of the cabinet within six inches of the top left corner.

Control, Normal power sensing and options wires connect most easily if they enter above the Remote station terminal or just below the Emergency sensing terminal on the left side of the cabinet.

**Note:** Do not run the control, normal power sensing and options wiring in the same conduit as Emergency phase or load power wiring.

Load wires in from the dimmer rack and out to the lighting loads connect most easily if they enter through the bottom of the cabinet either between or beside the transfer switch assemblies.

**Note:** Except for the emergency power supply wires, which must enter near the top left corner of the cabinet, recommended conduit entry locations may be changed based on your installation requirements.

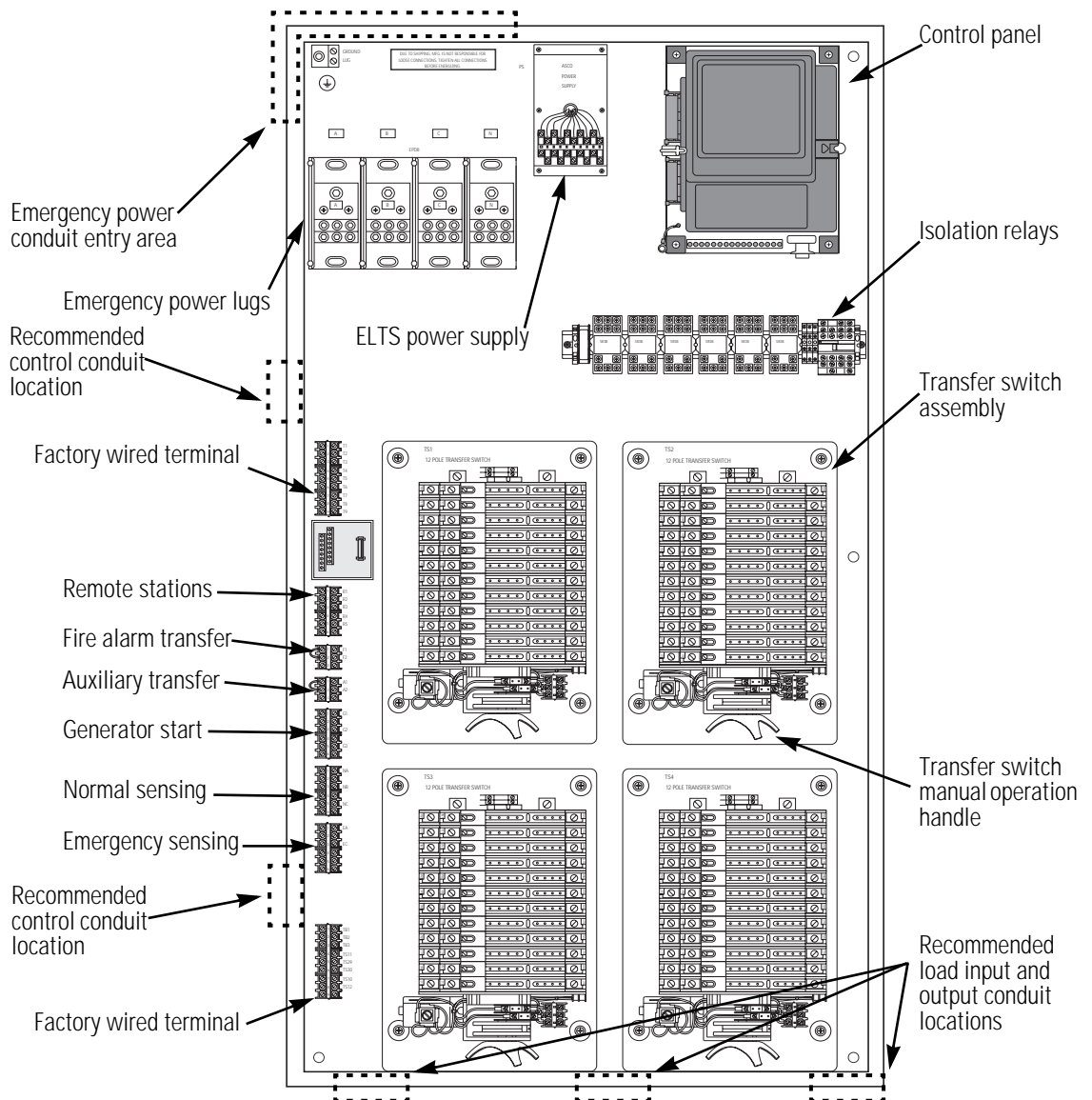

Figure 6: ELTS components

## Mounting the cabinet

After determining where you want to install the cabinet, follow these instructions.

1. Install two 3/8" bolts 24.25 inches apart for the lower two support slots (the installer must supply the mounting hardware).
2. Use the mounting dimensions from *Figure 5: ELTS cabinet mounting dimensions* on page 9 to drill the holes for the upper two 3/8" bolts.
3. Place the ELTS cabinet on the wall supported by the two lower bolts.



**Caution** *ELTS cabinets are very heavy. Make sure you have adequate equipment (or help) to lift the cabinet into place and support it while you secure the top two bolts.*

4. Secure the ELTS to the wall with the two upper 3/8" bolts.

## Installing Remote stations (optional)

1. Install a standard two gang backbox (4" x 4" x 3.5") and run conduit from it to the ELTS cabinet.
2. Pull five conductor, Class 2 (12 Vdc) wiring through from the backbox to the cabinet.
3. Connect the wires to the terminal strip on the back of the remote station. Make a note of each wire's terminal assignment.

Connect the five conductor class 2 wires to terminals 1, 2, 3, 4 and 5 (wire colors may vary)

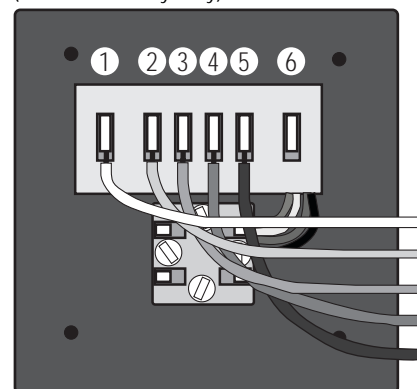
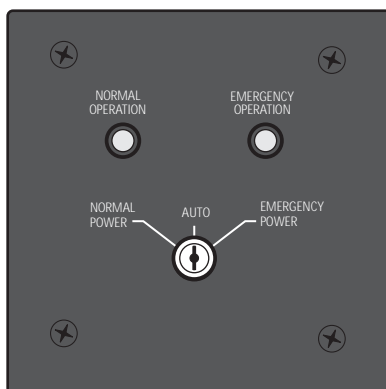

Figure 7: Remote station terminal connections

4. Install the Remote station onto the backbox with four 6 - 32 x 1/2" oval head machine screws (provided).
5. To install multiple Remote stations, repeat steps 1 – 4, wiring in parallel between Remote station terminal blocks.

**Note:** *To avoid confusion, use the same wire terminal assignment at each Remote station you install.*

Refer to *Connecting Remote stations to the ELTS* on page 17 for instructions for connecting Remote station wiring inside the ELTS cabinet.

# Connecting power and control wiring to the ELTS cabinet



**Warning!** To prevent death or injury due to electrical shock, Normal and Emergency power to the ELTS must be turned off any time you are connecting or servicing any ELTS.

## Connecting Emergency power (standard systems)

**Note:** Standard ELTS systems connect Emergency power to phase lugs and distribute it through pre-wired overload protection circuitry. Discrete systems do not have Emergency power lugs. Go to Connecting Emergency power (Discrete systems) on page 13 for instructions.

The Emergency power lugs are in the upper left of the ELTS cabinet. The ELTS is available in one or three phase power configurations.

1. Cut a hole within six inches of the top left corner of the ELTS cabinet

**Note:** Top conduit connections are recommended to reduce the cable bending necessary to connect to the lugs.

2. Install conduit and pull the Emergency power cables into the cabinet.
3. Using Figure 9, below, connect phase power cable to the correct lug:

▼ **Three phase** power cables connect to lugs **A, B, and C**

▼ **Single phase** power cables connect to lugs **A and B**

**Note:** You cannot connect an ELTS designed for three phase operation to single phase power or a single phase ELTS to a three phase source.

4. Connect the Neutral cable to the Neutral lug.
5. Connect the Ground cable to the Ground lug.

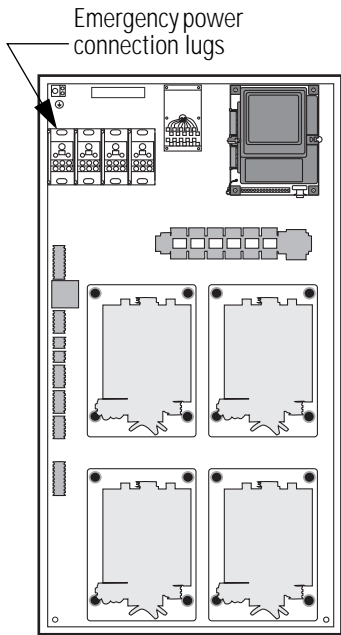

Figure 8: Emergency lugs

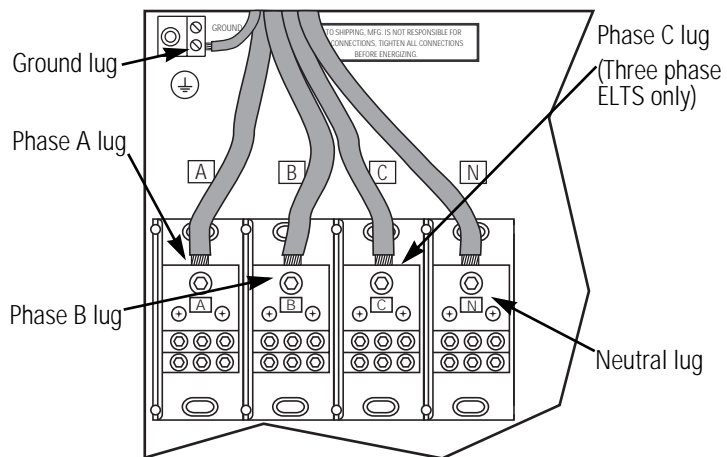

Figure 9: Connecting Emergency power to the ELTS

Table 1: Emergency power lug wire sizes and connection torques

Connection type	Wire size	Torque
Phase and Neutral lugs (3 phase)	6 AWG to 2/0	275 in/lbs
Phase and Neutral lugs (single phase)	6 AWG to 250 MCM	275 in/lbs
Ground lug (both phase types)	14 AWG to 2/0	50 in/lbs

6. Go to Connecting lighting circuit wires to transfer switches on page 14 for instructions on connecting lighting load wires.

## Connecting Emergency power (Discrete systems)

A Discrete ELTS does not have Emergency power lugs. Instead, Discrete systems wire emergency feeds directly to transfer switch Emergency inputs. Transfer switch assemblies connect either 20 amp circuits (up to six), or 50 amp circuits (up to two).

**Note:** *Discrete ELTS systems require external distribution and overload protection circuitry.*

1. Attach the conduit for the wires from the dimmer rack to the bottom of the ELTS cabinet (recommended.)
2. Pull Emergency feed Line and Neutral wires to the Emergency feed terminals on the right side of the transfer switches. See Figure 10, left, to match switch assembly load assignments.
3. Connect the Ground lug in the upper left corner to building Ground with a 14AWG to 2/0 wire and torque it to 50 in/lbs.
4. Connect Emergency feed Neutral wires to the **EN**-labeled terminals.
  - ▼ 20 amp switches – connect Neutral wires to **EN1** through **EN6**
  - ▼ 50 amp switches – connect Neutral wires to **EN1** and **EN2**
5. Connect Emergency feed Line wires to the **EL**-labeled terminals.
  - ▼ 20 amp switches – connect Neutral wires to **EL1** through **EL6**
  - ▼ 20 amp switches – connect Neutral wires to **EL1** and **EL2**
6. Repeat steps 2 and 3 for the other transfer switch assemblies.

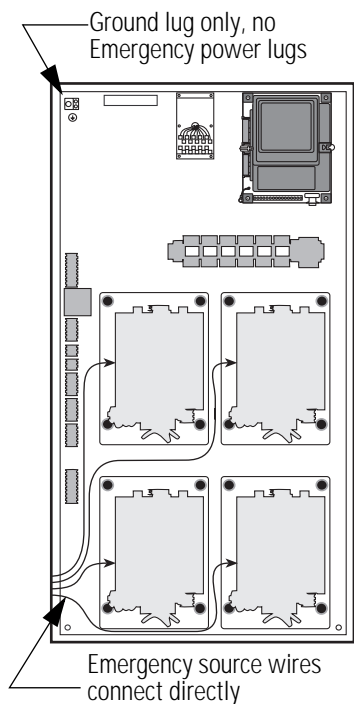

Figure 10: Discrete Emergency connections

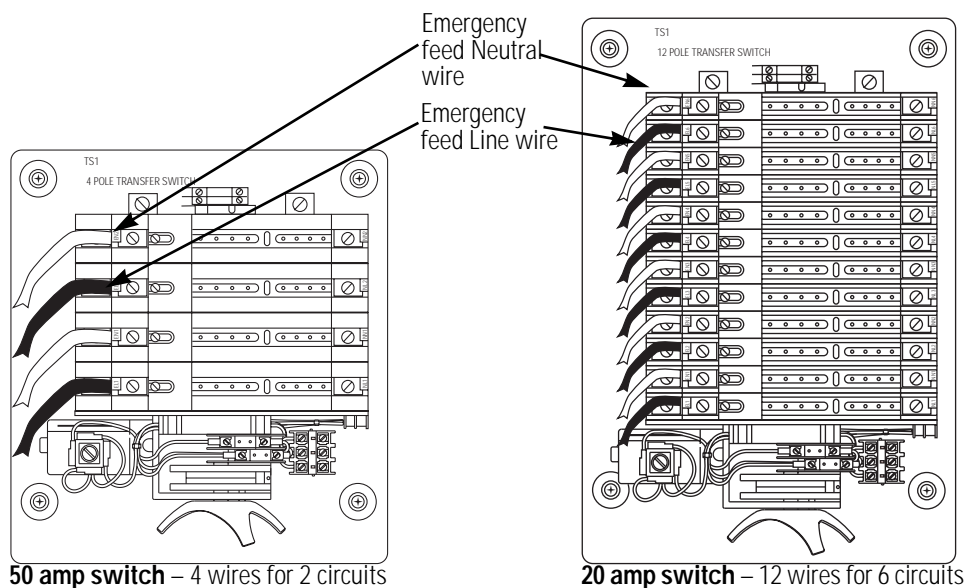

Figure 11: 50 and 20 amp transfer switch Emergency feed connections

7. Torque the connections to the correct values using Table 2, below.

Table 2: Switch assembly wire sizes and connection torques

Wire size	Torque	Wire size	Torque
14 – 10 AWG	35 in/lbs	8 AWG	40 in/lbs
6 – 4 AWG	45 in/lbs	3 AWG to 2/0	50 in/lbs

## Connecting lighting circuit wires to transfer switches

Each transfer switch can have up to six 20 amp circuits or two 50 amp circuits connected to it. You need to connect Line and Neutral inputs from the dimmer rack and outputs to the emergency lighting loads.

Table 3: Switch assembly wire sizes and connection torques

Wire size	Torque	Wire size	Torque
14 – 10 AWG	35 in/lbs	8 AWG	40 in/lbs
6 – 4 AWG	45 in/lbs	3 AWG to 2/0	50 in/lbs

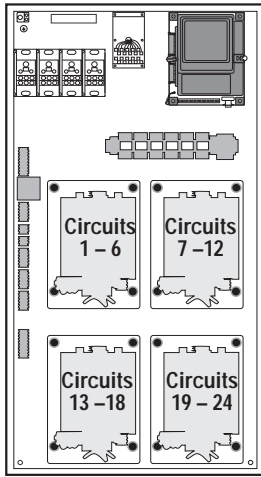

Figure 12: 20 amp Transfer switch circuit assignments

### 20 amp dimmer rack Load and Neutral wire input connections

1. Attach the conduit for the wires from the dimmer rack to the bottom of the ELTS cabinet (recommended.)
2. Connect a Neutral wire for each dimmer circuit to terminals **NN1** through **NN6** on the right side of the transfer switch assembly. See Figure 12, left, to match switch assemblies to loads.
3. Connect a Line wire for each dimmer circuit to terminals **NL1** through **NL6** on the right side of the transfer switch assembly.
4. Repeat steps 2 and 3 for the other transfer switch assemblies.

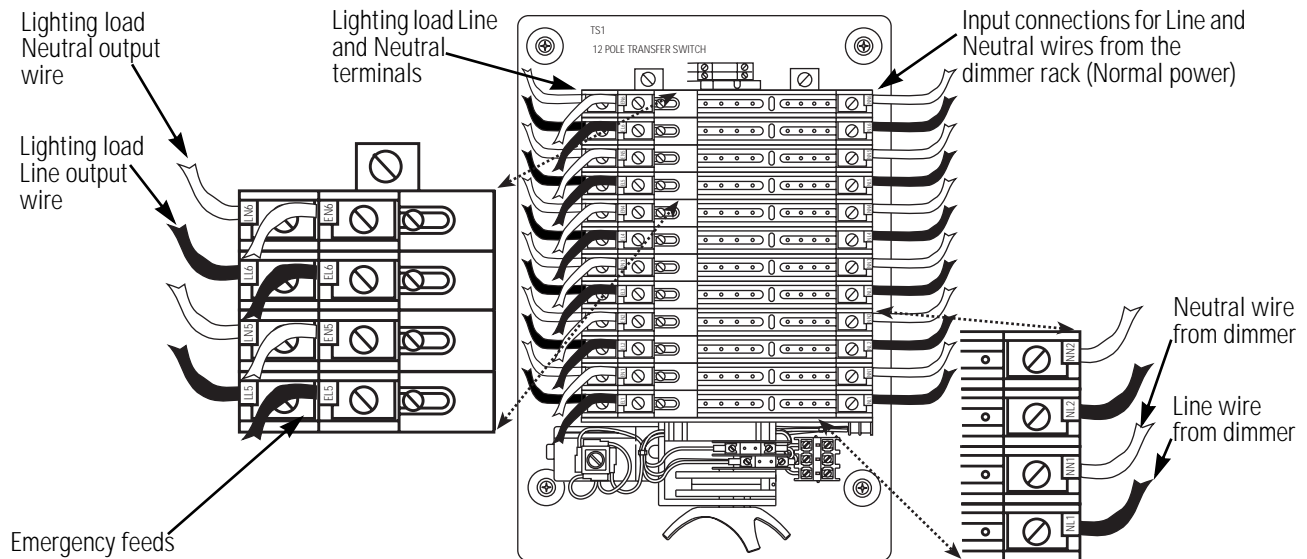

Figure 13: 20 amp Transfer switch connections for Line and Neutral wires

### 20 amp lighting load Line and Neutral output connections

1. Attach the conduit for the wires to the lighting loads through the bottom of the ELTS cabinet (recommended.)
2. Connect a Neutral wire for each lighting load to terminals **LN1** through **LN6** on the left side of the transfer switch assembly. See Figure 12, above, to match switch assemblies to loads.
3. Connect a Line wire for each lighting load to terminals **LL1** through **LL6** on the left side of the transfer switch assembly.
4. Repeat steps 2 and 3 for the other transfer switch assemblies.

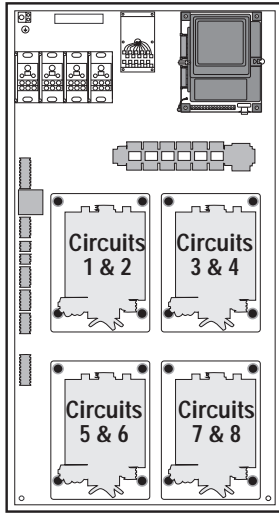

Figure 14: 50 amp transfer switch circuit assignments

### 50 amp dimmer rack Load and Neutral wire input connections

1. Attach the conduit for the wires from the dimmer rack to the bottom of the ELTS cabinet (recommended.)
2. Connect a Neutral wire for each dimmer circuit to terminals **NN1** and **NN2** on the right side of the transfer switch assembly. See Figure 14, left, to match switch assemblies to loads.
3. Connect a Line wire for each dimmer circuit to terminals **NL1** and **NL2** on the right side of the transfer switch assembly.
4. Repeat steps 2 and 3 for the other transfer switch assemblies.

### 50 amp lighting load Line and Neutral output connections

1. Attach the conduit for the wires to the lighting loads through the bottom of the ELTS cabinet (recommended.)
2. Connect a Neutral wire for each lighting load to terminals **LN1** and **LN2** on the left side of the transfer switch assembly. See Figure 14, to match switch assemblies to loads.
3. Connect a Line wire for each lighting load to terminals **LL1** and **LL2** on the left side of the transfer switch assembly.
4. Repeat steps 2 and 3 for the other transfer switch assemblies.

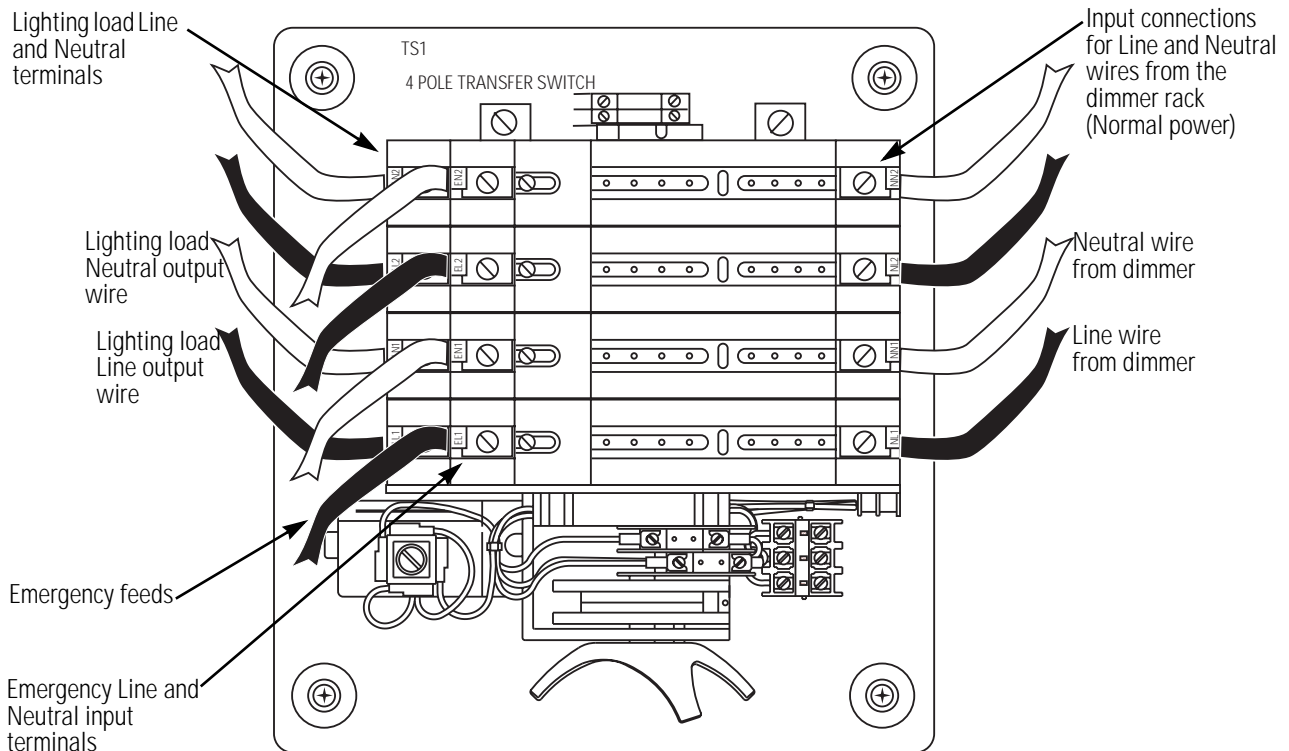

Figure 15: 50 amp Transfer switch connections for Line and Neutral wires



## Control and sensing wire connections

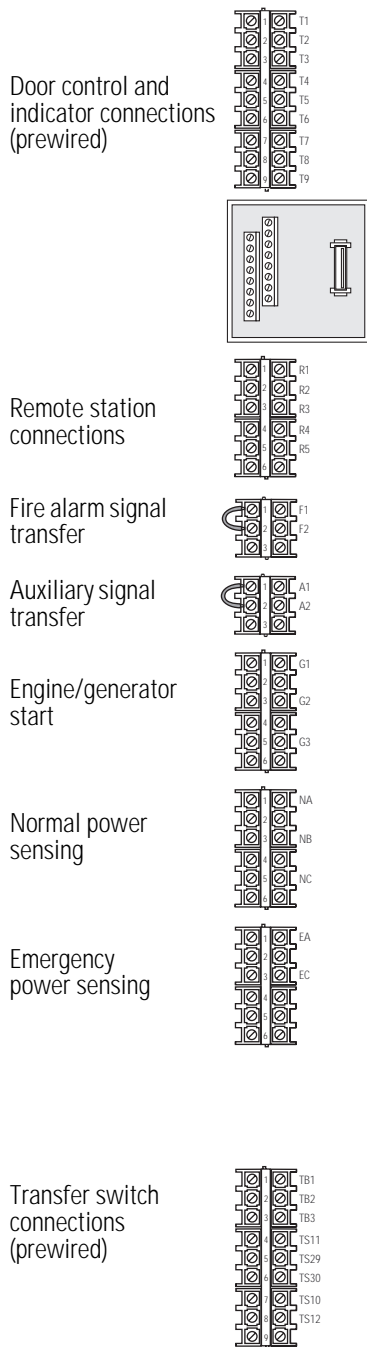

Figure 16: Control and Sensing wire terminal connections

Control and power sensing wires connect to terminal blocks on the left side of the ELTS cabinet.

Terminals accept 8 to 22 AWG wires. Torque terminal screws to 18 in/lbs.

1. Install control and sensing wire conduit on the left side of the ELTS cabinet above the remote station connection terminals or below the Emergency power sensing terminals (recommended conduit location).
2. Pull the wires into the cabinet.

### Connecting the Normal power sensing wires

Normal power sensing wires connect to the phase lugs of the dimmer rack connected to the ELTS. They attach to the Normal power sensing terminal block. Each sensing wire must connect to the ELTS through a 15 amp circuit breaker located *outside* the ELTS cabinet.

**Note:** Power sensing wires must be 12 AWG or larger.

1. Connect a sensing wire to each phase lug of the dimmer rack connected to the ELTS. Mark each wire to identify its phase at the ELTS rack.
2. Connect each sensing wire to a 15 amp circuit breaker close to the dimmer rack. Circuit breakers *cannot* be installed in the ELTS cabinet.
3. Pull the wires from the circuit breakers through conduit to the Normal power sensing terminal block in the ELTS cabinet.
4. Connect the sensing wires to the Normal power sensing terminal block:
  - ▼ Phase A to terminal 1 (across from red 12AWG wires labeled NA)
  - ▼ Phase B to terminal 3 (across from unlabeled white 14AWG wire)
  - ▼ Phase C to terminal 5 (across from red 12AWG wires labeled NC)

**Note:** On single phase (three wire) systems, terminal 5 will not be used.

### Connecting the Emergency power sensing wires

Emergency power sensing wires on Standard ELTS systems with front panel circuit breaker or fuse panels are wired from the Emergency power lugs to the correct terminals on the Emergency power terminal block at the factory.

Emergency power sensing wires on Discrete ELTS systems without front panel circuit breakers must be wired into the ELTS cabinet.

**Note:** Emergency power sensing wires must be 12 AWG or larger and connect through an external 15 amp circuit breaker.

1. Connect a sensing wire to phase **A** and **C** (**A** and **B** on single phase systems) of the Emergency power supply. Mark each wire to identify its phase at the ELTS rack.
2. Pull the wires through the conduit to the Emergency power sensing terminal block in the ELTS cabinet.
3. Connect the sensing wires to the Emergency sensing terminal block:
  - ▼ Connect phase A to terminal 1 (across from wire EA)
  - ▼ Connect phase C to terminal 3 (across from wire EC)

**Note:** On single phase (three wire) ELTS systems, connect phase B to terminal 3.



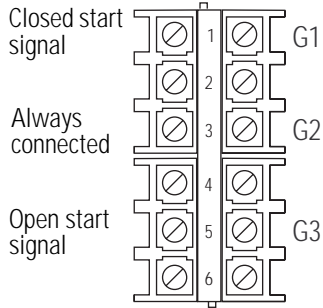

Figure 17: Connections for Engine/generator starting wires

### Connecting the Engine/generator starting wires

The ELTS system can provide both normally open and normally closed starting circuits for engine generator activation.

1. Connect two wires to the terminals of your engine/generator starting circuit.

**Note:** Consult your generator installation manual for start signal wiring information.

2. Pull the wires through the conduit to the engine/generator start terminal block.
3. Connect one of the starting wires to terminal 3 (across from wire G2).
4. Connect the other starting wire to terminal 1 or 5:
  - ▼ For a closed start signal, connect the wires to terminal 1 (across from wire G1)
  - ▼ For an open start signal, connect the wires to terminal 5 (across from wire G3)

### Connecting Remote stations to the ELTS

You can connect up to 10 Remote stations to the ELTS with parallel wiring.

1. Pull the Remote station wires to the ELTS Remote station terminal.

**Note:** You must know the wire assignments used at the Remote station being connected. For Remote Station installation instructions see page 11.

2. Connect Remote terminal wire 1 (Common) to terminal 1.
3. Connect Remote terminal wire 2 (Emergency Select) to terminal 4.
4. Connect Remote terminal wire 3 (Normal Select) to terminal 5.
5. Connect Remote terminal wire 4 (Normal indicator LED) to terminal 2.
6. Connect Remote terminal wire 5 (Emergency indicator LED) to terminal 3.

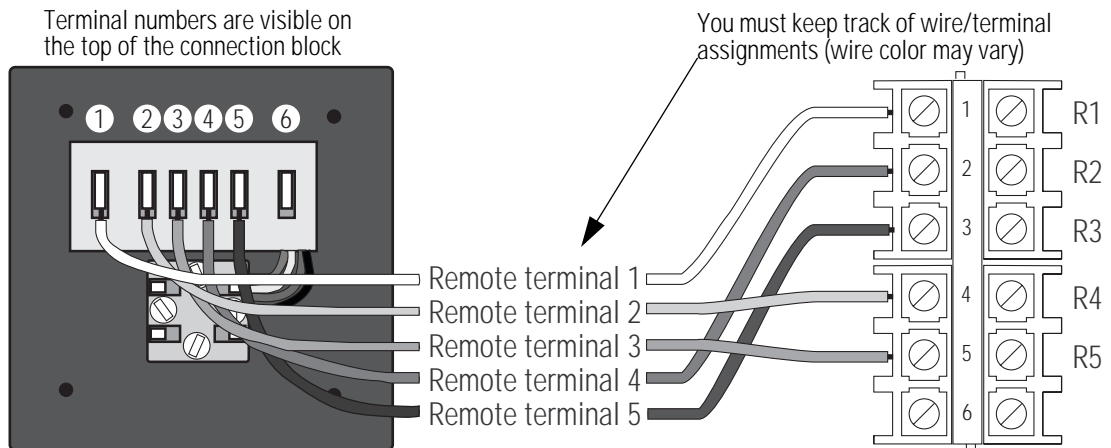

Figure 18: Remote Station terminal connections (to ELTS connector)

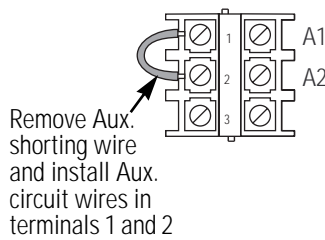
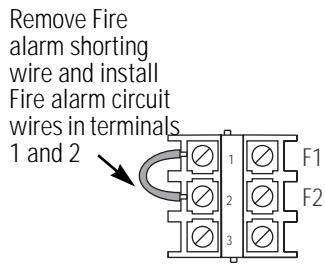

Figure 19: Connecting fire alarm and auxiliary circuit wires

### Connecting fire alarm activation

You can connect your ELTS to your fire alarm system so it switches to Emergency when the alarm is triggered. Your fire alarm system must be able to provide an open signal when it activates.

1. Connect two wires to the terminals of your fire alarm activation circuit.
2. Pull the wires through the conduit to the fire alarm terminal block.
3. Remove the shorting wire between terminal 1 and terminal 2.
4. Connect one wire to terminal 1 (across from wire F1).
5. Connect the other wire to terminal 2 (across from wire F2).

**Note:** If you do not use the fire alarm activation feature, leave the shorting wire in place or the ELTS will not operate properly.

### Connecting auxiliary activation

You can connect your ELTS to an auxiliary circuit so it switches to Emergency when the circuit is triggered. Your auxiliary circuit must provide an open signal when it activates.

1. Connect two wires to the terminals of your auxiliary circuit.
2. Pull the wires through the conduit to the auxiliary terminal block.
3. Remove the shorting wire between terminal 1 and terminal 2.
4. Connect one wire to terminal 1 (across from wire A1).
5. Connect the other wire to terminal 2 (across from wire A2).

**Note:** If you do not use the auxiliary activation feature, leave the shorting wire in place or the ELTS will not operate properly.

# Testing

## Before you power up for the first time

### Checking transfer switch operation manually

By checking transfer switch manual operation before you apply power, you reduce the possibility of failure caused by mechanically frozen, damaged or obstructed switches. Each switch should rotate without catching or binding.



**Warning!** Normal and Emergency power should be off when you open the ELTS cabinet to check switch operation. Opening the cabinet with power applied may result in death or injury from electrical shock.

1. Open the ELTS cabinet.



**Warning!** Rotating the transfer switch assemblies manually with Normal or Emergency power applied may result in the assemblies switching automatically, causing severe hand injuries.

2. Turn the manual operation handle 90° clockwise. **E** (Emergency) should be visible on the assembly about 1.5 inches above the handle.
3. Rotate the handle 180° counter-clockwise. **N** (normal) should be visible.

**Note:** If you have difficulty operating the switch, check for installation debris that may be blocking switch operation.

4. Repeat steps 2 and 3 with the remaining transfer switch assemblies.

## Turn on system

### Voltage checkout

1. Apply power to the ELTS and connected dimmer rack at the main circuit breaker. The green Normal LED lights.
2. Apply emergency power. The red Emergency light turns on.



**Warning!** ELTS voltage tests should only be performed by qualified personnel using extreme caution. Opening the cabinet with power applied exposes you to death or injury from electrical shock.

3. Open the ELTS cabinet.
4. Use a digital voltmeter (DVM) to test the feed voltage at the Normal power sensing terminal block (Figure 16 on page 16 for location). Phase A is on terminal 1, phase B on terminal 3 and phase C on terminal 5. Voltage must be within  $\pm 10$  percent of the rated voltage for the ELTS.
5. Use the DVM to test the feed voltage at the Emergency power lugs. Phase lugs are labeled either **A**, **B** or **C**. Voltage values must be within  $\pm 10$  percent of the rated voltage for the ELTS.
6. Close the ELTS cabinet.

## Functional checkout

After verifying the Normal and Emergency voltages, check the ELTS system functions.

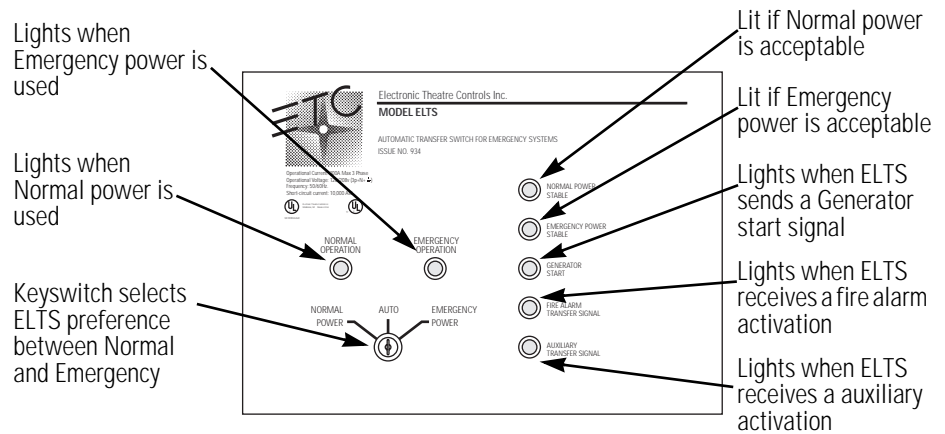

Figure 20: Local control operation and LED indications

### Switch function

1. Insert the key into the keyswitch on the front panel of the ELTS.
2. Turn the key to **EMERGENCY POWER**. The red light above **EMERGENCY OPERATION** turns on and the emergency loads go to full brightness. If Emergency power is provided by an engine/generator, there will be a short delay as the generator turns on and the voltage and frequency stabilize.
3. Release the key. The keyswitch returns to **AUTO** (center) and the **EMERGENCY OPERATION** light remains on.
4. Turn the key to the **NORMAL POWER** position. The green light below **NORMAL OPERATION** turns on if the system is functioning correctly.
5. Release the key. The keyswitch returns to **AUTO** and the **NORMAL OPERATION** light remains on.

### Remote switch functions

After confirming correct function of the keyswitch on the front of the ELTS cabinet, repeat the switch function checkout procedure at every remote station installed on your system.

## Automatic function

The automatic function tests the ELTS's ability to switch back and forth from Normal to Emergency when Normal power is interrupted or restored.

1. Make sure the **NORMAL OPERATION** LED is lit on the ELTS front panel.
2. Turn off Normal power to the dimmer rack connected to the ELTS.
  - ▼ The **NORMAL OPERATION** and **NORMAL POWER STABLE** LEDs on the ELTS front panel go out
  - ▼ The ELTS switches to Emergency power (the **EMERGENCY OPERATION** and **EMERGENCY POWER STABLE** LEDs light, and the emergency loads go to full brightness)
  - ▼ If Emergency power is provided by an engine/generator, there will be a short delay before switching as the generator turns on and the voltage and frequency stabilize
3. Restore Normal power.
  - ▼ The ELTS switches back to Normal power after the retransfer delay times out (the default setting is thirty minutes)
  - ▼ On the front of the ELTS, the **EMERGENCY OPERATION** and **EMERGENCY POWER STABLE** LEDs turn off and the **NORMAL OPERATION** and **NORMAL POWER STABLE** LEDs light
  - ▼ If used, the Emergency power engine/generator turns off when the cool down time is complete.

## Options function

ELTS systems can also be activated by fire alarm and auxiliary circuits. Both are operated by a normally closed circuit controlled by the fire alarm or auxiliary relays. When the fire alarm or auxiliary circuit activates, the relay opens, causing the ELTS to switch to Emergency power. To test option relay function, either:

1. Activate the fire alarm or auxiliary relay.
  - ▼ The ELTS should switch to Emergency power and the emergency loads should go to full
2. If you do not wish to activate the fire alarm or auxiliary circuit, generate an open circuit at the ELTS connection to the fire alarm or auxiliary circuit by disconnecting one of the two wires to the ELTS cabinet.
  - ▼ The ELTS will switch to Emergency power and the emergency loads should go to full

**Note:** *The second method tests the ELTS response to an open circuit, but does not confirm the fire alarm or auxiliary relay's ability to open the circuit to the ELTS.*

# ELTS Timing, Voltage, and Line settings

Factory settings for timing, source voltage, and line frequency work best for most installations. If necessary, you can adjust settings after installation.



**Warning!** Improper setting changes may affect normal operation of the ELTS and result in switching function failure. Only make changes to timing, voltage, and frequency settings if you are familiar with the system.

Table 4: ELTS timing settings

Delay type	Factory setting	Adjustment range	Adjusted by
Override Normal source outage delay	3 seconds	1 or 3 seconds	DIP switch S3 – 1
Transfer to Emergency delay	0 seconds	0 seconds - 5 minutes	Potentiometer P2
Return to Normal delay	5 minutes	1 second - 30 minutes	Potentiometer P1
Override Emergency source outage delay	4 seconds	Not adjustable	N/A
Generator cool down (unloaded run time)	5 minutes	Not adjustable	N/A

Table 5: ELTS Phase frequency settings

Description	Factory setting	Adjustment range	Adjusted by
Single or three phase operation	Set at factory	1Ø or 3Ø	DIP switch S1 – 6
Phase frequency	As indicated for application	50Hz or 60Hz	DIP switch S1 – 4
Emergency Source frequency pickup	95% of line frequency	47Hz or 57Hz	Phase frequency setting
Emergency Source frequency dropout	85% of line frequency	43Hz or 51Hz	Phase frequency setting

Table 6: ELTS source voltage settings:

120v ELTS voltage settings	Factory setting	Adjustment range	Adjusted by
Normal source voltage pickup	108 volts	108 or 114 volts	DIP switch S1 – 3
Normal source voltage dropout	102 volts	108, 102, 96, or 84 volts	DIP switch S1 – 1, 2
Emergency source voltage pickup	108 volts	No adjustment	N/A
Emergency source voltage dropout	90 volts	No adjustment	N/A
277v ELTS voltage settings	Factory setting	Adjustment range	Adjusted by
Normal source voltage pickup	249 volts	249 or 263 volts	DIP switch S1 – 3
Normal source voltage dropout	235 volts	249, 235, 222, or 193 volts	DIP switch S1 – 1, 2
Emergency source voltage pickup	249 volts	No adjustment	N/A
Emergency source voltage dropout	208 volts	No adjustment	N/A
Voltage Adjust (120v and 277v)	Factory setting	Adjustment range	Adjusted by
<b>Low</b> reduces all voltage settings 4.2%	<b>High</b> (100%)	<b>High</b> – 100% or <b>Low</b> – 95.8%	DIP switch S3 – 2

**Note:** Voltage Adjust also reduces Emergency Pickup and Dropout voltages. See Table 7 on page 25 for voltage values when Voltage Adjust is set to **LOW**.

## Changing ELTS settings

You adjust ELTS settings on the control panel by opening the cabinet and removing the control panel cover in the ELTS enclosure.

### Gaining access to the ELTS control panel

1. Disconnect both ELTS power sources. Disconnect Emergency first, then Normal. If the ELTS was using the Emergency source, you may hear the actuators switch over to Normal.
2. Open the ELTS cabinet and locate the ELTS control panel using Figure 21.



**Warning!** Opening the ELTS cabinet with power on may result in death or injury from electrical shock.

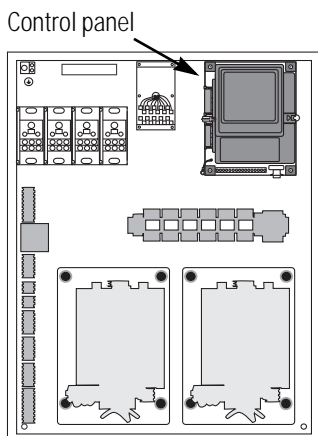

Figure 21: Control panel

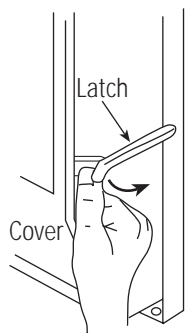

Figure 22: Removing the control panel cover

3. Release the latch on the right side of the control panel cover and lift the cover off to the right. See Figure 22, left.
4. Use Figure 23, below, to locate the desired adjustment component.

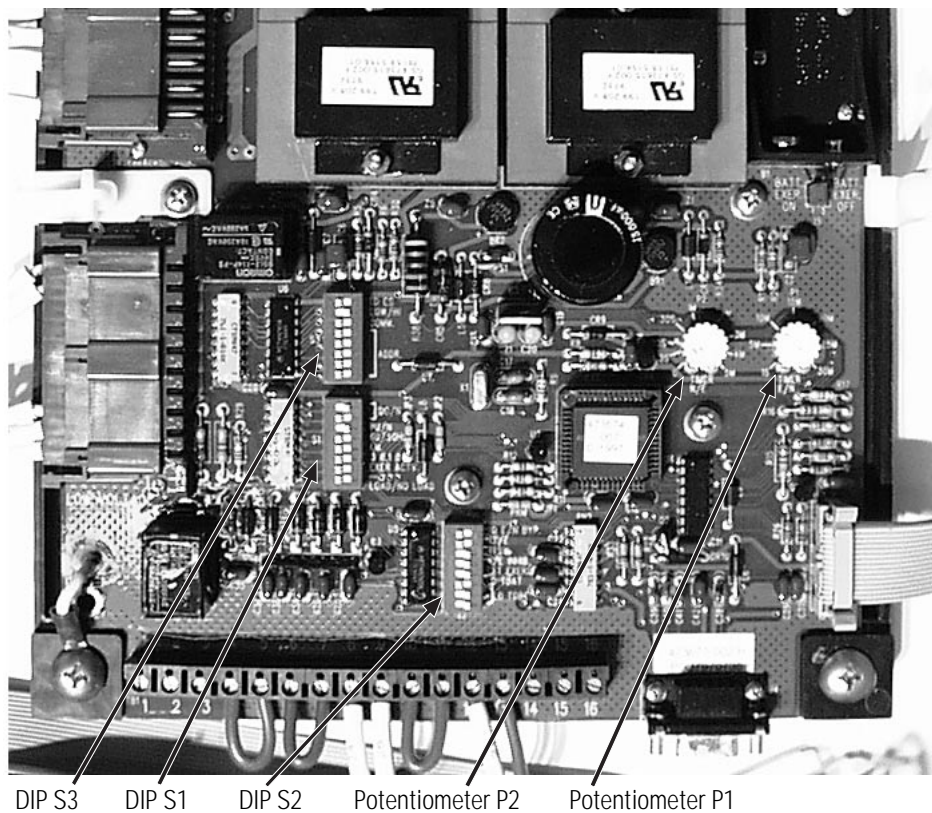

Figure 23: Adjustment potentiometer and DIP switch locations

5. Use the instructions on the following pages to make the desired changes:
  - ▼Instructions for ELTS Timing settings are on page 24
  - ▼Instructions for ELTS Voltage settings are on page 25
  - ▼Instructions for ELTS Line settings are on page 26



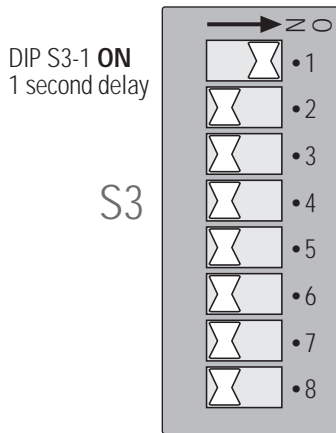
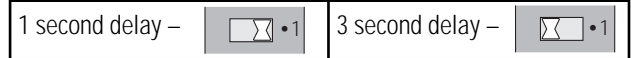

Figure 24: Dip Switch S3-1

### Changing the Normal source outage delay

The Normal source outage delay is the amount of time the ELTS will tolerate a Normal power voltage fault before starting the switch to Emergency power. It can be set to 1 or 3 seconds using DIP switch S3-1.

1. Locate S3 using Figure 23 on page 23 and set S3-1 to the desired setting.



### Changing the Transfer to Emergency and Return to Normal delays

The Transfer to Emergency delay is the time the ELTS waits before switching to Emergency after the Emergency power voltage and frequency stabilize. You can set the delay from zero to five minutes, using potentiometer P2.

The Return to Normal delay is the time the ELTS waits before switching from Emergency to Normal after Normal power is stabilized. The delay can be set from one second to 30 minutes using potentiometer P1.

**Note:** To quickly restart an interrupted performance or for testing purposes, you can instantly switch the ELTS back to Normal power with the front panel Local switch or a Remote keyswitch station.

1. Locate potentiometer P1 (Emergency to Normal) or P2 (Normal to Emergency) using Figure 23 on page 23.
2. Turn the potentiometer clockwise to increase the interval or counterclockwise to decrease it. Use the adjustment values marked on the PCB to approximate the desired delay.

**Note:** Markings are approximate – you may need to test settings with a timing device to achieve exact delay values.

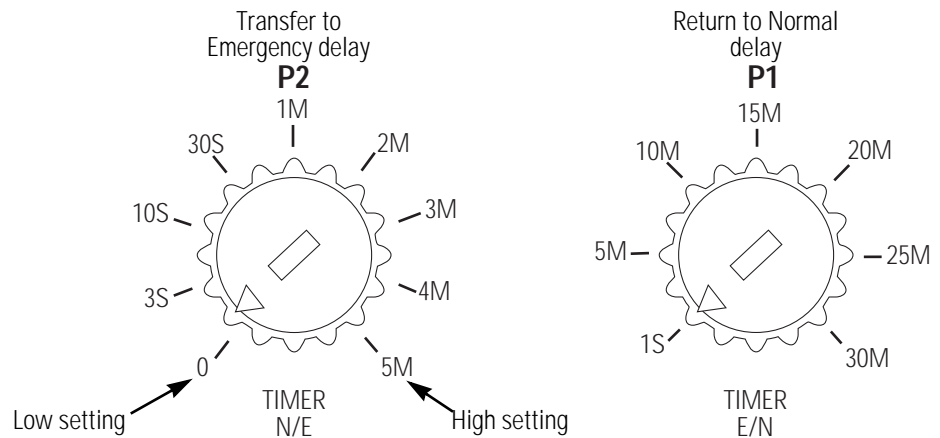

Figure 25: P2 (Transfer to Emergency) and P1 (Return to Normal)

### Override Emergency source outage delay

The Override Emergency source outage delay is the time the ELTS will tolerate an Emergency power fault before starting the switching back to Normal power. It is set at the factory to four seconds and cannot be adjusted.

### Generator cool down interval

The Generator cool down interval is the time the ELTS waits before shutting off the Emergency power generator after switching back to Normal power. It is set at the factory to five minutes and cannot be adjusted.



DIP S3-2 **On**,  
All voltage settings  
are at 100 percent  
of factory settings  
(**Norm** setting)

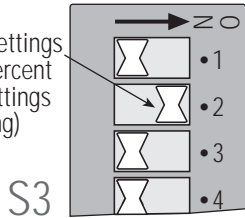

Figure 26: Dip Switch S3-2

### Changing the Voltage Adjust setting

Voltage Adjust is set at **Low** or **Norm** using DIP switch S3-2. **Low** reduces all voltage settings by 4.2 percent to compensate for low source voltage.

1. Locate S3-2 using Figure 23 on page 23 and set it to the desired setting.

Voltage Adjust <b>Norm</b> –	Voltage Adjust <b>Low</b> –
------------------------------	-----------------------------

Table 7: ELTS source voltage settings with Voltage Adjust set to **Low**

120v ELTS voltage settings	Factory setting	Adjustment range	Adjusted by
Normal source voltage pickup	103.5 volts	103.5 or 109.2 volts	DIP switch S1 – 3
Normal source voltage dropout	97.7 volts	103.5, 97.7, 92.0, or 80.5 volts	DIP switch S1 – 1, 2
Emergency source voltage pickup	103.5 volts	No adjustment	N/A
Emergency source voltage dropout	86.2 volts	No adjustment	N/A
277v ELTS voltage settings	Factory setting	Adjustment range	Adjusted by
Normal source voltage pickup	238.5 volts	238.5 or 252.0 volts	DIP switch S1 – 3
Normal source voltage dropout	225.1 volts	238.5, 225.1, 212.7, or 184.9 volts	DIP switch S1 – 1, 2
Emergency source voltage pickup	238.5 volts	No adjustment	N/A
Emergency source voltage dropout	199.3 volts	No adjustment	N/A

### Changing the Normal source Pickup voltage

The Normal source Pickup voltage is the voltage level required before the ELTS will switch from the Emergency source back to Normal power. It is set using DIP switch S1-3.

1. Locate S1-3 using Figure 23 on page 23 and set it to the desired setting.

DIP S1-1 and S1-2,  
Normal source  
Dropout voltage  
-----  
DIP S1-3, Normal  
source Pickup  
voltage (shown in  
**On** position)

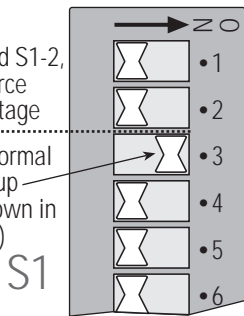

Figure 27: Dip Switch S1

	120v operation		277v operation	
Voltage Adjust <b>Norm</b>	108v	114v	249v	263v
Voltage Adjust <b>Low</b>	103.5v	109.2v	238.5v	252v

### Changing the Normal source Dropout voltage

The Normal source Dropout voltage is the voltage level where the ELTS will switch from the Normal source to Emergency power. It is set using DIP switches S1-1 and S1-2.

1. Locate S1-1 and S1-2 using Figure 23 on page 23 and set the voltage.

	120v operation				277v operation			
Voltage Adjust <b>Norm</b>	108v	102v	96v	84v	249v	235v	222v	193v
Voltage Adjust <b>Low</b>	103.5v	97.7v	92v	80.5v	238.5v	255.1v	212.7v	184.9v

### Emergency source Pickup and Emergency source Dropout voltages (not adjustable)

The Emergency source Pickup voltage is the lowest voltage level that allows the ELTS to use Emergency instead of Normal power.

The Emergency source Dropout voltage is the lowest voltage level the ELTS can use for Emergency power operation.

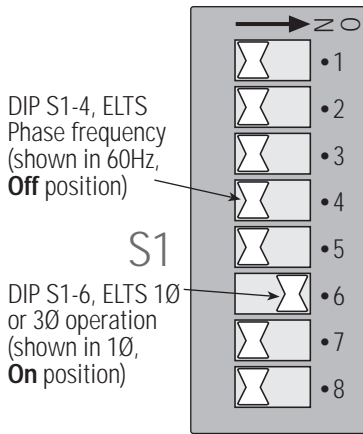
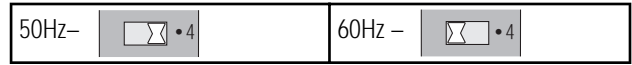

Figure 28: Dip Switch S1

### Setting ELTS line frequency

The ELTS can be set for either 50 or 60Hz operation using DIP switch S1-4.

1. Locate S1-4 using Figure 23 on page 23 and set it as desired.



### Setting the ELTS for single or three phase voltage

The ELTS can be set for either single or three phase operation using DIP switch S1-6.

**Note:** *The ELTS is shipped with a different internal wiring configuration and power supply for either single or three phase operation. Do not change the phase setting unless directed to do so by an authorized ETC representative.*

1. Locate S1-6 using Figure 23 on page 23 and set it as desired.



### Emergency source Pickup and Emergency source Dropout frequency settings

The Emergency source Pickup frequency is the lowest line frequency needed for the ELTS to use the Emergency source to replace Normal power. It is set at the factory to 95 percent of the ELTS phase frequency and cannot be adjusted, but does use the ELTS phase frequency for its 50 or 60Hz reference.

The Emergency source Dropout frequency is the lowest line frequency the ELTS can tolerate when using Emergency power. It is set at the factory at 85 percent of the ELTS phase frequency and cannot be adjusted, but does use the ELTS phase frequency for its 50 or 60Hz reference.

50Hz ELTS setting		60Hz ELTS setting	
Pickup – 47.50Hz	Dropout – 42.5Hz	Pickup – 57.0Hz	Dropout – 51.0Hz

# Operation

## Automatic operation

During automatic operation the ELTS system switches back and forth from Normal to Emergency when either power supply is interrupted or restored.

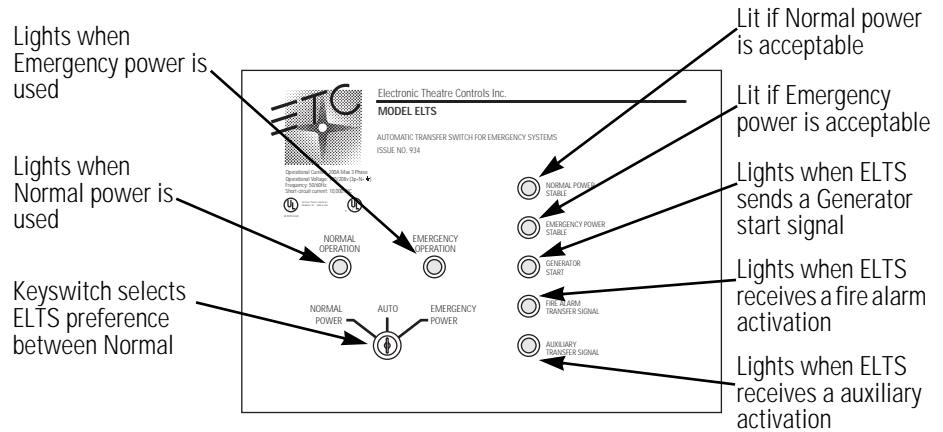

Figure 29: Local control LED indications

## Selecting the preferred power source: Normal or Emergency

Using the local keyswitch on the front of the ELTS cabinet or a Remote keyswitch station installed in your facility, you can select either Normal or Emergency as the preferred power source.

1. Insert the key into the keyswitch and select the desired power source:
  - ▼ To select Normal power, turn the key left. The green **NORMAL OPERATION** LED lights.
  - ▼ To select Emergency power, turn the key right. The red **EMERGENCY OPERATION** LED lights and the emergency loads go to full. If Emergency power is provided by an engine/generator, there will be a short switching delay as the generator turns on and voltage and frequency stabilize.
2. Release the key. The keyswitch returns to center and the indicator light you selected remains on. The ELTS uses the selected power source. If the selected source's voltage or frequency drops below the limit, the ELTS will switch to the other source.
3. When the voltage and frequency of the selected source returns to acceptable levels, the ELTS will switch back to it.

## Remote Station

Remote Keyswitch station operation is identical to the local station. Refer to *Selecting the preferred power source: Normal or Emergency* for instructions.

## Fire alarm or Aux signal switching

If desired, the ELTS system can be activated by fire alarm or auxiliary circuits. When the ELTS receives the fire alarm or auxiliary circuit activation, it will switch to Emergency power.

**Note:** *If you have selected Emergency as the preferred power with either the Local or Remote keyswitch, the ELTS will not switch power sources after receiving a fire alarm or auxiliary activation.*

## Switching power sources manually

If you need to switch the ELTS from one power source to another when the electronic switching circuits will not function (for example, if you needed to use either Normal or Emergency power, but the voltage or frequency was below the limit) you can set the transfer switch assemblies manually.

1. Disconnect both Normal **and** Emergency power.



**Warning!** Turn off Normal and Emergency power to the ELTS at the main circuit breaker. Opening the cabinet with power applied may result in death or injury from electrical shock.

2. Open the ELTS cabinet.
3. Disconnect the two connectors on the left side of the control panel.

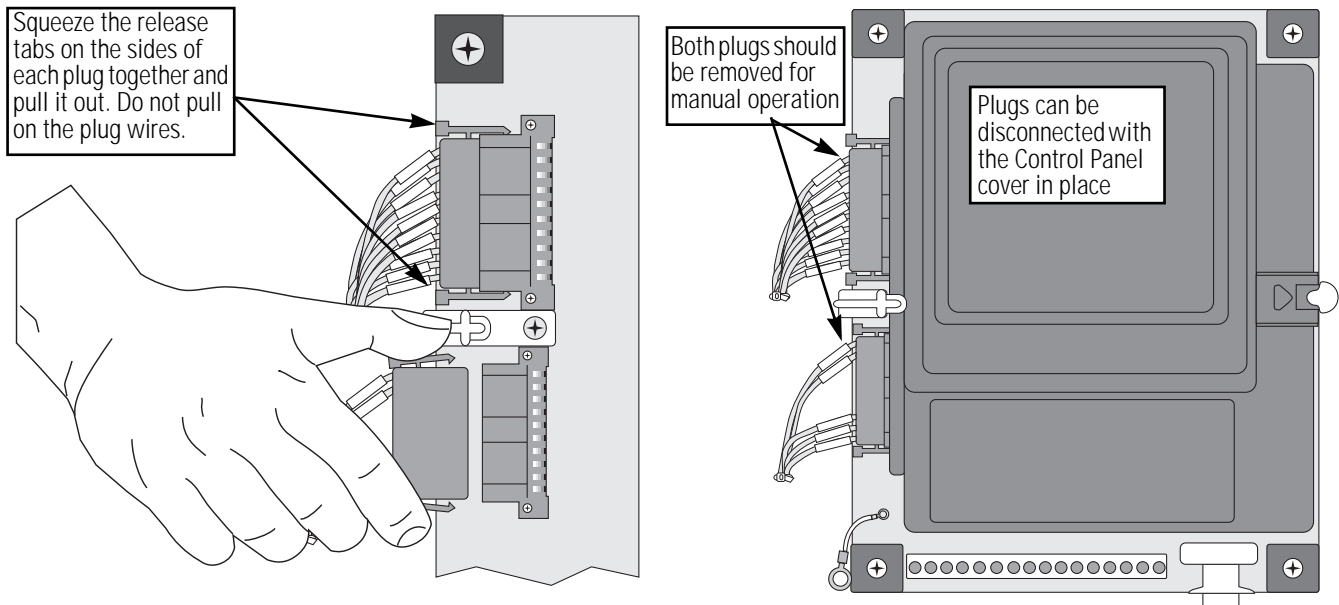

Figure 30: Removing the control panel connector



**Warning!** Operating switch assemblies manually without disconnecting the control panel connector may result in the assemblies switching back automatically, causing severe hand injuries.

- ▼ To switch from Normal to Emergency power: Turn the manual operation handle on the bottom of each transfer switch assembly 90° clockwise. **E** (Emergency) should be visible just above the handle.
  - ▼ To switch from Emergency to Normal: Turn the manual operation handle on the bottom of each transfer switch assembly 90° counter-clockwise. **N** (normal) should be visible just above the handle.
4. Close the cabinet door and restore power to the ELTS.

**Note:** Do not plug the control panel connectors back in until you want the ELTS to resume automatic operation.



### Restoring automatic operation

1. Disconnect Normal and Emergency power.

**Warning!** *Turn off Normal and Emergency power to the ELTS at the main circuit breaker. Opening the cabinet with power applied may result in death or injury from electrical shock.*

2. Open the ELTS cabinet.
3. Reconnect the two connectors on the left side of the control panel (See Figure 30 on page 28).
4. Close the cabinet door and restore power to the ELTS.

# Service

## Preventive maintenance

Regular testing and simple maintenance of your ELTS system will result in long service life and reliable performance. To assist in documenting your test and maintenance schedule, a blank *Test and Maintenance Log* is included on page 38. We suggest you post a copy near your ELTS cabinet.



**Warning!** Turn off Normal and Emergency power to the ELTS at the main circuit breaker. Opening the cabinet with power applied exposes you to death or injury from electrical shock.



**Warning!** Rotating the transfer switch assemblies manually with Normal or Emergency power applied may result in the assemblies switching automatically, causing severe hand injuries.

### Monthly testing

1. Manually test the ELTS's transfer function at the local keyswitch on the front of ELTS cabinet. See *Switch function* on page 20 for keyswitch instructions and indications.
2. Note the test results in the test and maintenance log.

### Quarterly testing and maintenance

1. Manually test the ELTS's transfer function at the local keyswitch on the front of ELTS cabinet. See *Switch function* on page 20 for keyswitch instructions and indications.
2. Test the ELTS Auto transfer function. See *Automatic function* on page 21 for automatic transfer instructions and indications.
3. Visually inspect the ELTS cabinet for loose wires or component damage.
4. Note the test results in the test and maintenance log.

### Annual testing and maintenance

1. Manually test the ELTS's transfer function at the local keyswitch on the front of ELTS cabinet. See *Switch function* on page 20 for keyswitch instructions and indications.
2. Test the ELTS Auto transfer function. See *Automatic function* on page 21 for automatic transfer instructions and indications.
3. Visually inspect the ELTS cabinet for loose wires or component damage.
4. Retighten ELTS phase, neutral and ground lugs using values in *Table 1: Emergency power lug wire sizes and connection torques* on page 12.
5. Vacuum the ELTS cabinet to remove dust and debris that may have collected.
6. Note the test results in the test and maintenance log.

# Troubleshooting

If you have trouble with an installed ELTS system, you can contact ETC Technical Service at 800/775-4382.



**Warning!** *Trouble shooting usually involves opening the ELTS cabinet and metering voltages. Opening the ELTS cabinet with power applied exposes you to death or injury from electrical shock. Use extreme caution during all troubleshooting activities.*

## Emergency or Normal Power Stable LED does not turn on properly

During normal operation, either the Normal Power Stable or Emergency Power Stable LED should be lighted. If one or the other does not light, the problem may be with the LED, Normal or Emergency sensing wiring, or Normal or Emergency power.

1. Switch between Normal and Emergency power on the ELTS control panel keyswitch and observe the results:
  - ▼ The ELTS switches between Normal and Emergency
    1. Check for loose LED wire connections or defective LEDs.
    2. Make sure the Control Panel connector is properly seated.
  - ▼ The ELTS does not switch between Normal and Emergency.
    1. Go to the next ELTS troubleshooting section.

## The ELTS will not switch between Normal and Emergency

### If the system will not switch from Emergency power

1. Check for tripped Normal power sensing wire circuit breakers.
2. If the circuit breakers are not tripped, meter Normal power using the procedures in *Voltage checkout* on page 19.

### If the system will not switch from Normal power

1. Meter Emergency power using the procedures in *Voltage checkout* on page 19.
2. If no fire alarm or auxiliary circuits are connected to the ELTS, make sure the terminal jumpers are in place.
3. If fire alarm or auxiliary circuits are connected, meter between the wires to be certain the circuit is closed. An open circuit switches the ELTS to Emergency power.

### If the system does not seem to function in either Normal or Emergency power mode

1. Make sure the control panel connector is properly seated.
2. Check other wire connections for loose terminals or broken wires.
3. Use the procedures in *Checking transfer switch operation manually* on page 19 to test the switching mechanism for mechanical problems.

## Remote stations cannot switch the ELTS

1. Switch between Normal and Emergency power on the ELTS control panel keyswitch and observe the results.

### If the ELTS does not switch locally

Follow the instructions in *The ELTS will not switch between Normal and Emergency* on page 31.

### If the ELTS switches locally

Try switching the ELTS from other Remote stations, if multiple stations have been installed

1. If the other stations function, check the wire terminal connections on the problem station. See *Installing Remote stations (optional)* on page 11 for station connection requirements.
2. If the other stations do not function, or there is only one Remote station installed.
3. Check the wire connections on the Remote station terminal block.
4. Check the Remote station fuse in the ELTS cabinet

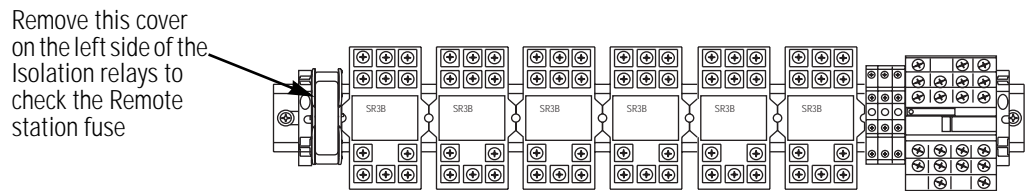

Figure 31: Locating the Remote station fuse

5. Inspect the wiring between the ELTS cabinet and the stations for defects. See *Connecting Remote stations to the ELTS* on page 17 for ELTS connection requirements.

## Some ELTS circuits do not switch when the system changes sources

Partial switching of ELTS circuits indicates one or more transfer switch assemblies, or the wiring to them, is defective.

1. Use the procedures in *Checking transfer switch operation manually* on page 19 to locate any transfer switch assemblies that have not switched and to manually test their function.
2. If an assembly cannot be switched manually, check for something that could be physically obstructing it. If you find something, remove it and manually test the switch again. If you cannot find and remove the cause of the switching failure, the assembly is defective and must be replaced.
3. If the assembly switches manually, check for loose wire connections to the assembly and look for damaged wires between the assembly and the control panel. Repair any wire problems you find and test the system.



# Appendix A: ELTS specifications

## Dimensions

Small cabinet: ELTS 450, ELTS 620, ELTS1220  
36" x 30" x 9"

Large cabinet: ELTS 850, ELTS 1820, ELTS 2420  
54" x 30" x 9"

## Weight

ELTS 450, ELTS 620, ELTS1220 – 305 pounds

ELTS 850, ELTS 1820, ELTS 2420 – 370 pounds

## Electrical

### Operational voltage

120/240V single phase 250 amp maximum

120/208V three phase 175 amp maximum

277/480V three phase 175 amp maximum

Frequency: 50 – 60Hz

Short circuit current: 10 kA @ 120/240V

100,000 kA @ 277/480V

(5 kA with 50 amp circuit breakers)

## Electrical Compliance

- ▼ ANSI/UL 1008 – Listed, Automatic Transfer Switches
- ▼ ANSI/NFPA 110 – Emergency and Standby Power Systems
- ▼ ANSI/NFPA 70 – National Electric Code
  - Article 701 – Legally Required Standby Systems
  - Article 700 – Emergency Systems
  - Article 540 – 11(c) – Motion Picture Houses
  - Article 520 – 7 – Theatres and Similar Locations
  - Article 518 – 3(c) – Places of Assembly
- ▼ City of New York, Advisory board, Electrical Department
- ▼ OSHA
- ▼ Department of Defense

## Environment

Ambient temperature between 32° F and 104°F (0°C and 40°C)

Humidity between 30 and 95 percent (non-condensing)

Altitude below 6500 feet (2000 meters)

# Appendix B: Wire connection schematics and diagrams

Wire connection schematics and diagrams are included to help you understand the internal wiring of your ELTS system.

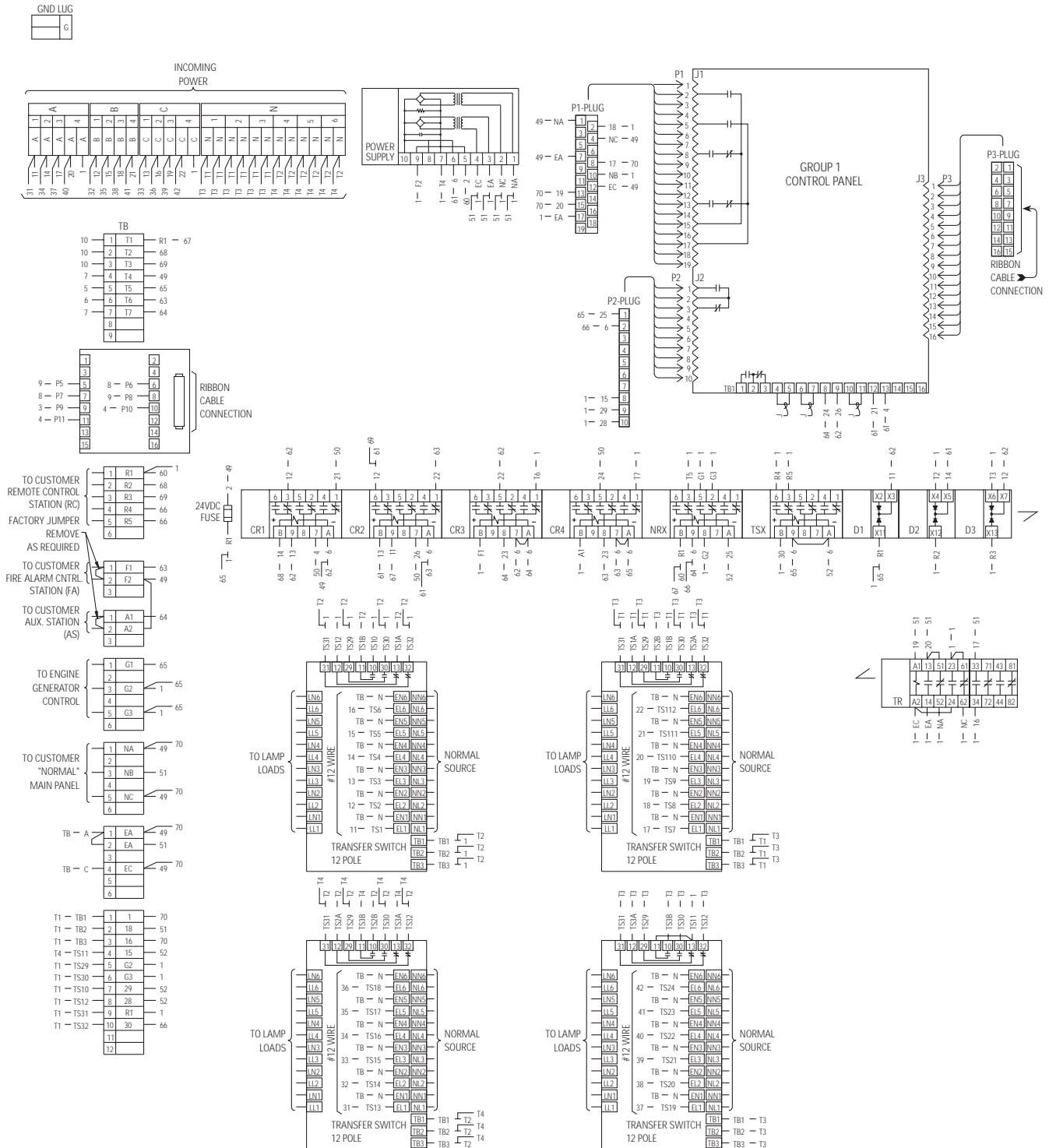
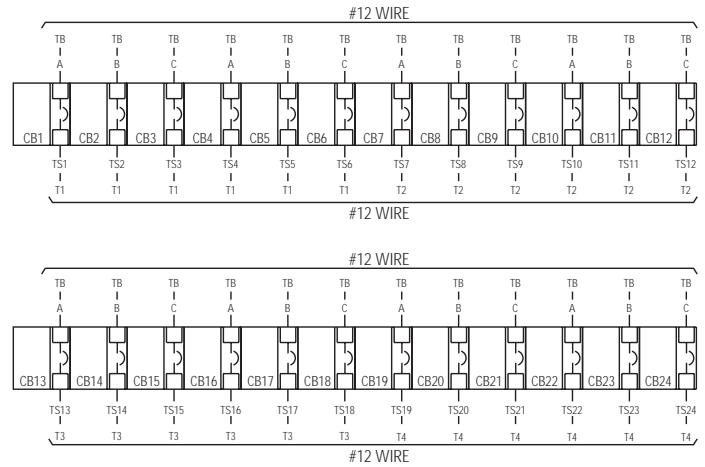
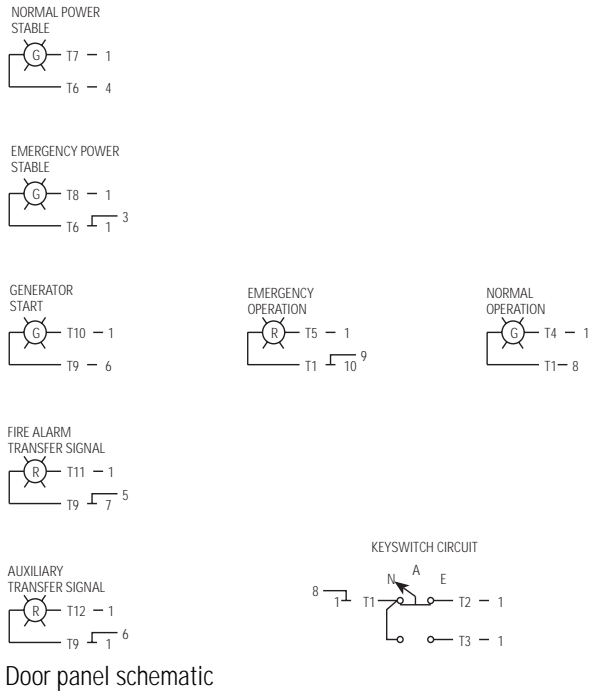

Figure 32: ELTS cabinet wire connection location diagram



Door panel schematic

Breaker bracket schematic

Figure 33: ELTS door panel and breaker bracket wire connection schematics

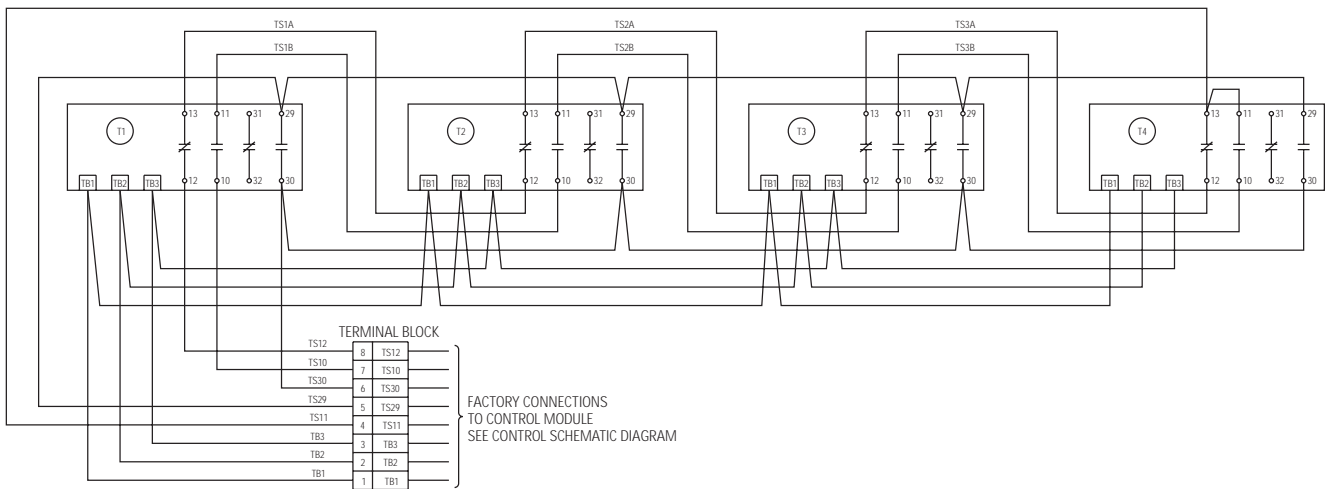
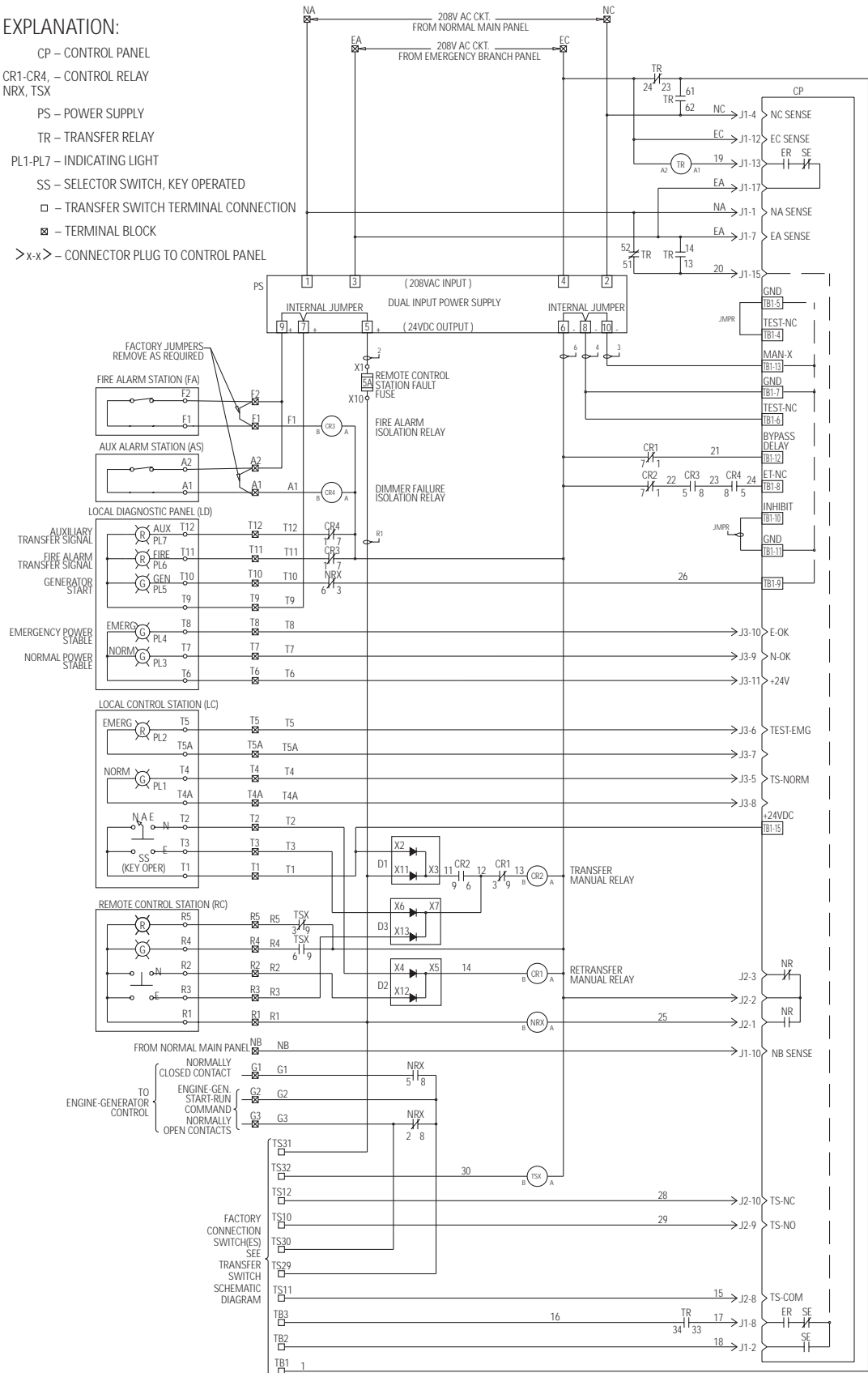

Figure 34: Transfer switch assembly control wire connections schematic

# Appendix C: Transfer switch control system schematics

## EXPLANATION:

- CP – CONTROL PANEL
- CR1-CR4, – CONTROL RELAY
- NRX, TSX
- PS – POWER SUPPLY
- TR – TRANSFER RELAY
- PL1-PL7 – INDICATING LIGHT
- SS – SELECTOR SWITCH, KEY OPERATED
- – TRANSFER SWITCH TERMINAL CONNECTION
- – TERMINAL BLOCK
- >x-x> – CONNECTOR PLUG TO CONTROL PANEL



# Appendix D: Transfer switch load switching schematic

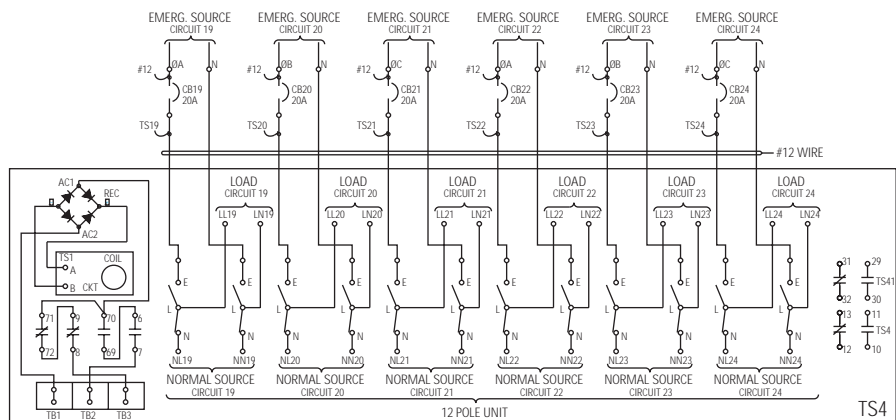
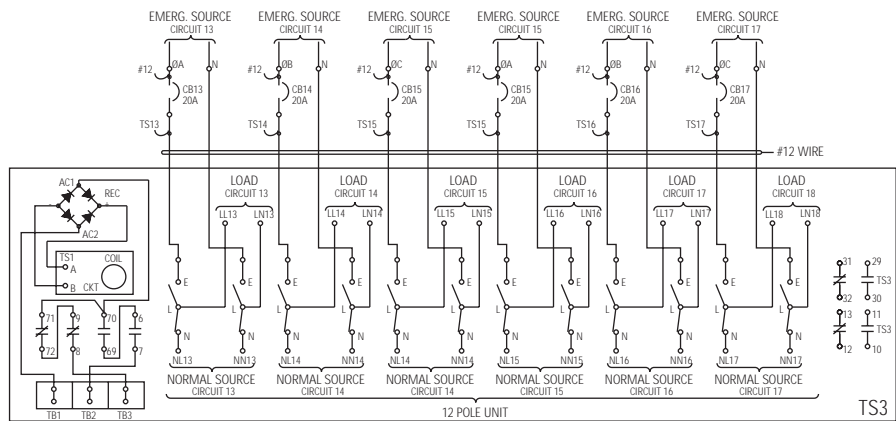
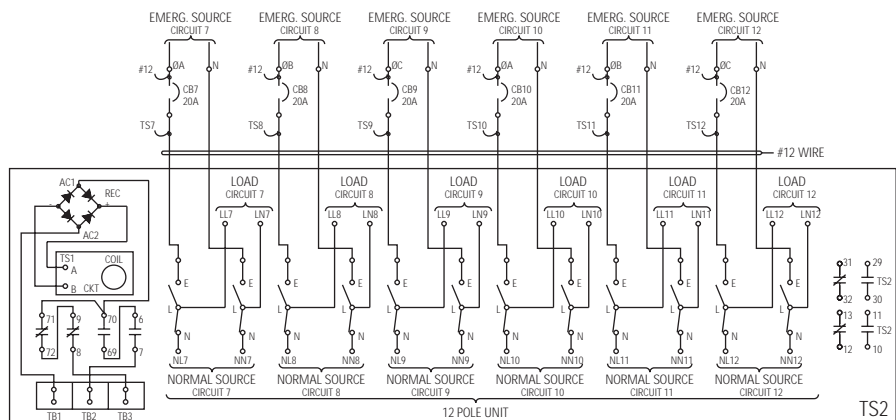
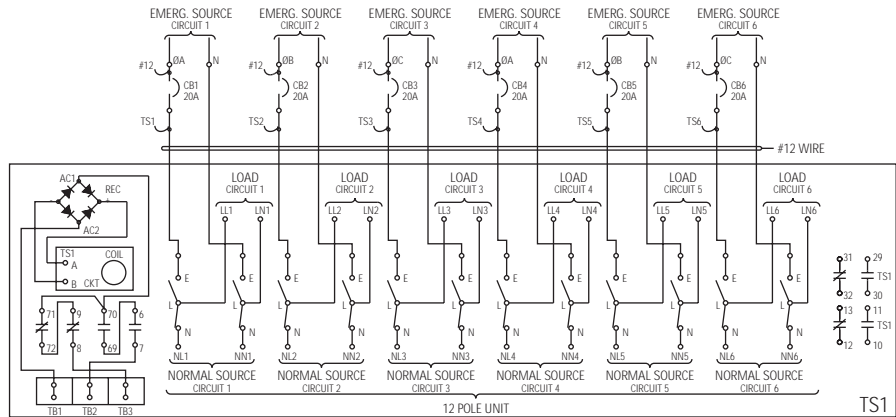

# Appendix E: Test and Maintenance Log

Date installed \_\_\_\_\_

System address \_\_\_\_\_

Service contact \_\_\_\_\_

Date	Inspected by	Manual transfer	Automatic transfer	Visual inspection	Vacuumed

## Appendix F: Glossary

Dimmed loads: A light or other fixture that operates using varying voltage from a power control device like a dimmer rack.

Dimmer: A device that varies operating voltages in response to signals from control devices.

Dimmer rack: An enclosure for multiple dimmers. Racks distribute source power, provide cooling and tamper protection.

ELTS: The Emergency Lighting Transfer System. It switches designated loads to an Emergency power source when a Normal power fault is detected.

Emergency source: A generator or other power supply that is not connected or dependent on normal facility power.

Normal/Emergency load: Lighting or other fixtures that may use the Normal source, but are also connected to an Emergency power source through the ELTS.

Normal source: The main or standard power supply for a facility.

Normal load: Lighting or other fixtures that depend on the Normal source for operating power.

Remote station: An extension of the ELTS front panel control to other locations in the facility.

Sense wires: Wires carrying voltage and frequency information from the Normal source to the ELTS control panel.

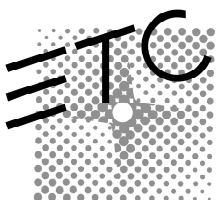

## Electronic Theatre Controls

**North America** 3030 Laura Lane • Middleton, Wisconsin 53562, USA • Tel: (+1) 608 831 4116 • Fax: (+1) 608 836 1736

**Europe** 5 Victoria Industrial Estate, Victoria Road • London, W3 6UU, England • Tel: (+44) 181 896 1000 • Fax: (+44) 181 896 2000

**Asia** Room 605-606, Tower III, Enterprise Square, 9 Sheung Yuet Road • Kowloon Bay, Hong Kong • Tel: (+852) 2799 1220 • Fax: (+852) 2799 9325

**Web** [www.etconnect.com](http://www.etconnect.com) • **Email** [mail@etconnect.com](mailto:mail@etconnect.com) • Copyright 1997-99 • Specifications subject to change • 1093M1102 • Revised 6/99